

EMEA VERSION



SPORTSMAN[®]

2019

ACCESSORIES + APPAREL



FOREVER OUTDOORS

SPORTSMAN® MODELS & ACCESSORIES (FULL LINEUP AT ATV.POLARIS.COM)

COMMON ACCESSORIES

PARTS & GARAGE

APPAREL & HELMETS

Sportsman® is legendary, giving you the ability to ride harder, go further and do more than any other ATV.

2019 LINEUP

RECREATION & UTILITY



SPORTSMAN® 450 H.O. (EPS)
33HP



SPORTSMAN® 570
44HP



SPORTSMAN® 850 SP
78HP



SPORTSMAN XP® 1000
90HP

TOURING



SPORTSMAN® TOURING 570 (EPS)
44HP

MUD & SPORT



SPORTSMAN XP® 1000 HIGH LIFTER EDITION
85HP



PRO ARMOR®
WHEELS & TIRES



POLARIS® PRO HD
WINCHES



RIGID® & PRO ARMOR®
LIGHTING



GLACIER® PLOW SYSTEMS



2019 POLARIS® SPORTSMAN® ACCESSORIES

POLARIS ENGINEERED® ACCESSORIES	04
WINCHES	08

SPORTSMAN®	
570 • 450	12
XP 1000 • 850	20
SCRAMBLER®	27

COMMON ACCESSORIES	
ESSENTIALS	28
OFF-ROAD GRADE AUDIO SYSTEMS	29
PRO ARMOR® WHEELS & TIRES	30
PROSPECTOR® PRO TRACKS / TECHNOLOGY	36
GLACIER® PLOW SYSTEMS	38
RIGID® & PRO ARMOR® LIGHTING	40
HUNT	42
POLARIS NORTHSTAR® COOLERS	44

PARTS & GARAGE	
OIL & LUBRICANTS	46
MAINTENANCE	50
SERVICE PARTS	52
GARAGE & TRAILERING	54

APPAREL & HELMETS	
RIDING GEAR	58
CASUALWEAR	60

KEEP YOUR STANDARDS HIGH

DESIGNED

POLARIS® OFFERS THE BROADEST LINEUP OF ACCESSORIES AND MOST INNOVATIVE SOLUTIONS IN OFF-ROAD. EACH ONE IS METICULOUSLY CRAFTED TO MATCH YOUR MACHINE.

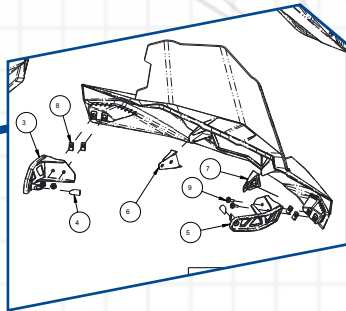

TESTED

BY THE TIME YOU GET THIS GEAR, PROTOTYPES HAVE GONE THROUGH HELL IN OUR LAB AND BEEN EXTENSIVELY TESTED IN THE FIELD. YOU RIDE WITH 100% CONFIDENCE.



TRUSTED

WE'VE EARNED RIDERS' TRUST OVER DECADES AND WE STAND BEHIND OUR WORK.

POLARIS® PARTNERS WITH THE BEST

We choose our partners carefully, selecting only the best in off-road. Every accessory is rigorously tested and validated at Polaris® standards, to ensure seamless integration and performance.

PRO ARMOR®



WHEELS & TIRES P. 38
LED LIGHTS P. 47



RIGID®

LED LIGHTS P. 46



KOLPIN® OUTDOORS

ACCESSORIES P. 48



MBQUART®

OFF-ROAD GRADE AUDIO P. 35



ENGINEERED

FOR MORE

Ensuring Polaris Engineered™ Accessories fit and work in sync with your machine is the most critical phase of testing and validation. With seamless integration, you can trust that any Polaris® accessory you install will enhance your interaction beyond your expectations.



LOCK & RIDE™

CARGO VERSATILITY

Lock & Ride® mounting locations allow for limitless customization to let you work the way you want.

PLUG & PLAY ELECTRICAL

Simple plug & play approach for adding power to Polaris Engineered™ Accessories.

PRO PRO HEAVY DUTY SERIES

WINCHES

INTEGRATED WINCH MOUNT & PRE-WIRED

Designated mounting points and pre-wired connectors ensure a perfect fit and the strongest place to attach the Polaris Engineered™ winch - the most dependable winch for your Sportsman®. With wiring built right into the vehicle, we made this the easiest Sportsman® winch ever made to install.

GLACIER® PLOW SYSTEM

INTEGRATED PLOW MOUNT

The attachment points for the best-in-class Glacier® Plow System are integrated right at the factory and feature an innovative drive-up and go installation process.

SUPERIOR

INTEGRATION

POLARIS
ENGINEERED

POLARIS® PRO HD WINCHES + GLACIER® PLOW SYSTEMS

Right from the factory, your vehicle is built to make essential accessories like winches and plows easy to use day-in and day-out. Mounting brackets are designed into the oversized factory bumper and wiring is routed securely and properly. When it comes to Sportsman®, Polaris Engineered™ Accessories make work easier so you can get more done.



POLARIS® PRO HD FEATURES



Tested **1,200+** pulls at max load, it works when you need it to



Built to withstand **-29° C** temperatures



Sealed motor & heavy duty gears **OPERATE FULLY SUBMERGED UNDERWATER**



RAPID ROPE RECOVERY
5X faster rope retrieval



MILITARY tested & approved

WINCHES

PLOWS

PRE-WIRED CHASSIS

Factory-installed wiring makes the controls simple to install. Mount the winch, connect the wires and trust that everything is routed safely, securely, and properly.

NO NEED TO CUT PANELS

FULLY INTEGRATED MOUNT & WIRING

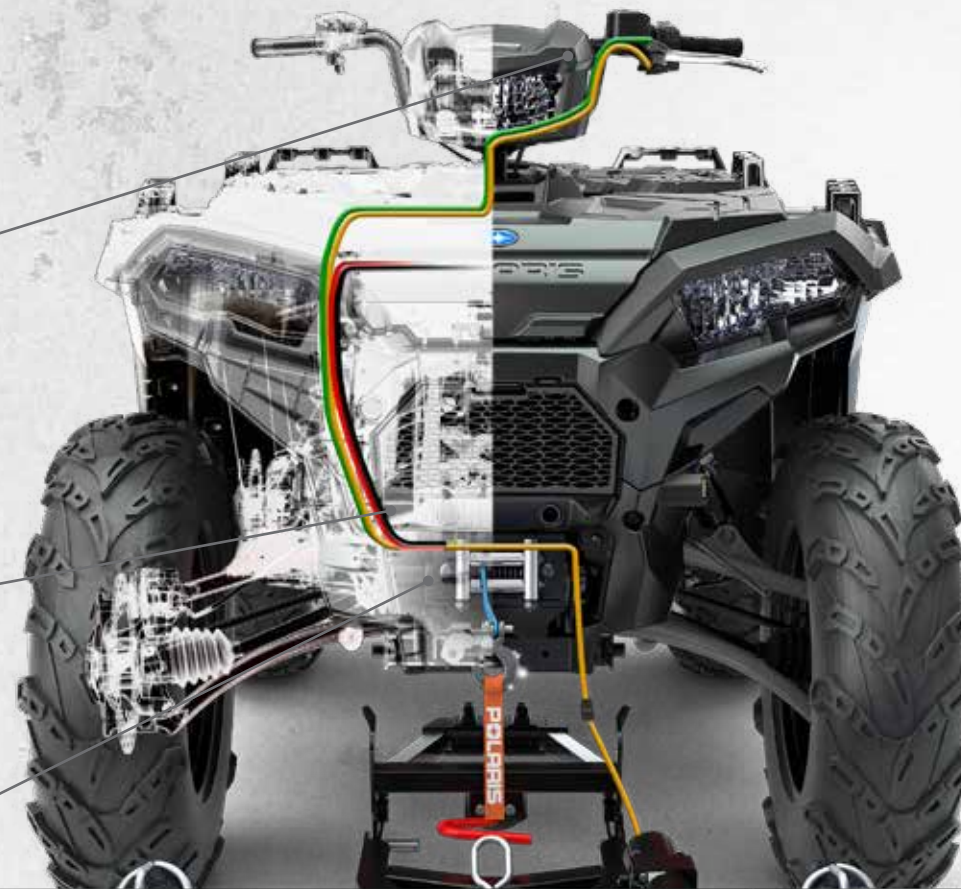

GLACIER® PLOW SYSTEM



GLACIER® FEATURES

- ✓ Easily engage and disengage the plow system from your Polaris® Sportsman®.
- ✓ No loss of factory ground clearance when not plowing.
- ✓ Don't have to crawl under the machine to release the plow blade from the vehicle.
- ✓ No trimming of vehicle plastic or fascia required to mount plow or winch.



SEE FULL PLOW LINEUP ON PAGE 38



CHOOSE THE
RIGHT WINCH
FOR YOU.

PRO PRO HEAVY DUTY SERIES

HID HEAVY DUTY SERIES

WINCH TYPES



RAPID ROPE RECOVERY	STANDARD	NOT AVAILABLE
AUTO STOP TECHNOLOGY	STANDARD	OPTION
SYNTHETIC ROPE	STANDARD	OPTION
FAIRLEAD	ALUMINUM	STEEL ROLLER
WIRELESS REMOTE	STANDARD	OPTION
HANDLEBAR CONTROL	OPTION	STANDARD
WINCHES AVAILABLE	1,588 kg	1,134 kg & 1,588 kg

PRO PRO HEAVY DUTY SERIES

PREMIUM FEATURES FOR **TOP-OF-THE-LINE POWER**

INDUSTRY 1ST TECHNOLOGY

RAPID ROPE RECOVERY



1. Set Winch Dial to FREE SPOOL (N) to attach Winch Hook
2. Set Winch Dial to PULL (L) for Winch Mode
3. Set Winch Dial to ROPE RECOVERY (H) for 5x Faster Rope Recovery

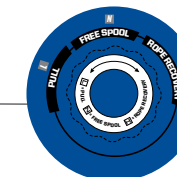

INTEGRATED WIRING INCLUDED

SEALED PERMANENT MAGNET MOTOR

CUT STEEL GEARS & SEALED DRIVETRAIN

AUTO STOP TECHNOLOGY

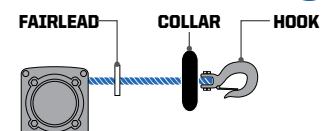

Winch stops when fairlead detects collar
Auto Stop Technology stops winch at end of pull to prevent driveline stress and plow overlifting

PREMIUM SYNTHETIC ROPE

- Lightweight & Easy to Handle
- Superior Flexibility
- Greater Strength than Steel Cable
- 15 m Long



HOOK WITH STRAP

WIRELESS REMOTE



15 m range wireless remote control with unique code for interference-free operation

HID HEAVY DUTY SERIES

PULLING POWER FOR **EVERYDAY USE & PERFORMANCE**

INTEGRATED WIRING INCLUDED

SEALED PERMANENT MAGNET MOTOR

INTEGRATED WIRED REMOTE

15 M STEEL CABLE

HOOK WITH STRAP



CUT STEEL GEARS & SEALED DRIVETRAIN

STEEL ROLLER FAIRLEAD

THERE'S A REASON THESE ARE THE BEST WINCHES ON THE MARKET.

Polaris® winches are fully sealed to keep out water, dust and other debris. Tested to ensure the heavy duty, quality components are strong enough to work when you need it the most.



✓ **TESTED 1,200+ PULLS AT MAX LOAD, IT WORKS WHEN YOU NEED IT TO**



✓ **SEALED MOTOR & HEAVY DUTY GEARS OPERATE FULLY SUBMERGED UNDERWATER**



✓ **BUILT TO WITHSTAND -29° C TEMPERATURES**



✓ **MILITARY TESTED & APPROVED**

PRO PRO HEAVY DUTY SERIES

PREMIUM FEATURES FOR TOP-OF-THE-LINE POWER



INDUSTRY 1ST NEW TECHNOLOGY

RAPID ROPE RECOVERY 5x FASTER

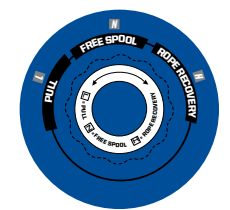

- RAPID ROPE RECOVERY**
1. Set Winch Dial to FREE SPOOL (N) to attach Winch Hook
 2. Set Winch Dial to PULL (L) for Winch Mode
 3. Set Winch Dial to ROPE RECOVERY (H) for 5x Faster Rope Recovery

PREASSEMBLED

Winch ready to install out of the box. Attached to mount and pre-wired.

WIRELESS REMOTE

15 m range wireless remote control with unique code for interference-free operation

PREMIUM SYNTHETIC ROPE

- Lightweight & Easy to Handle
- Superior Flexibility
- Greater Strength than Steel Cable
- 15 m Long

AUTO STOP TECHNOLOGY

Auto Stop Technology stops winch at end of pull to prevent driveline stress and plow overlifting

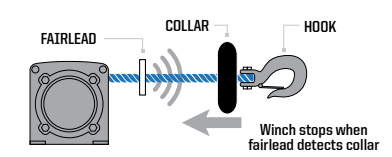

HID HEAVY DUTY SERIES

PULLING POWER FOR EVERYDAY USE & PERFORMANCE



- Cut steel gears for improved durability
- Steel spool can handle extreme loads
- 40% quieter – near-silent free spooling

- Sealed motor and drivetrain
- High-powered contactor
- Integrated wiring and mount plates ensure perfect fit

UPGRADE YOUR POLARIS® HD WINCH WITH THESE ACCESSORIES

POLARIS® WIRELESS WINCH REMOTE

» 2879316
ALL SPORTSMAN® AND POLARIS ACE® MODELS

POWER CONTROLLER

- Allows the rider to control plow angle and blade height from inside the cab

» 2880836
ACE® 570 '15-19, ACE® 500 '17-19

POLARIS® AUTO-STOP TECHNOLOGY WINCH UPGRADE KIT

- Requires use of synthetic cable rope (not included)

» 2881693
ALL SPORTSMAN® AND POLARIS ACE® MODELS

REPLACEMENT STEEL CABLE

- 50' x 3/16"

» 2879919
1,134 KG WINCHES

SYNTHETIC WINCH ROPE

- Includes pre-woven loop

» 2878888
1,134 KG & 1,588 KG WINCHES

WHY UPGRADE TO SYNTHETIC?

- Easier to work with - flexible and smooth texture
- More durable for plow usage
- Doesn't kink or bind like steel cable
- Lighter weight - even floats on water

NEW RECOVERY STRAP

- 5cm x 9m (8165 kg)
- 8,165 kg Breaking Strength / 4,082 kg Max. Vehicle Weight
- Comes with carry bag

» 2884033

		PRO PRO HEAVY DUTY SERIES	HID HEAVY DUTY SERIES	
	MODEL	1,588 KG WINCH SERIES	1,588 KG WINCH SERIES <i>with Synthetic Rope</i>	1,134 KG WINCH SERIES
POLARIS® SPORTSMAN®	450 H.O. '16-19 570 '14-19 570 SP '15-19 570 X2 '15-19 TOURING 570 '14-19 570 X2 SP '16-19 570 6X6 '17-19	2882242	TOP SELLER 2880434	TOP SELLER 2880432
	XP 1000 / 850 SP / 850 '15-19 TOURING XP 1000/850 '15-19 XP 1000 / 850 HIGHLIFTER EDITION '16-19 SCRAMBLER XP® 1000/850 '14-19** **MY14-15 REQUIRE CABLE (2879919)	2882241	TOP SELLER 2880435	2880433
	POLARIS ACE 570 SP '15-17 900 SP '16 500 '17-19 570 '16-19 900 XC '17-19	2882243	TOP SELLER 2882106	2882105

ALL WINCHES COME PRE-ASSEMBLED. NO ADDITIONAL COMPONENTS REQUIRED.

ACCESSORIES

WINCHES

570-4950

XP 1000-850

AUDIO & ESSENTIALS

WHEELS & TIRES TRACKS

PLOW

LIGHTING

HUNT & COOLERS

TRAIL



SPORTSMAN® 570 SP
Magnetic Gray Metallic

WORK



SPORTSMAN® 570 EPS Utility Edition
Ghost Gray

570 • 450 SPORTSMAN®

MAKE IT YOURS

WORK HARD AND GET IT DONE with Polaris Engineered™ Accessories for your Sportsman®. Start with the ultimate in ATV performance and comfort, then add in lighting, wheels, tires, a winch, Glacier® plows and more. Find everything you need to outfit your trusted partner for the task at hand.

HUNT



SPORTSMAN® 570 SP
Polaris® Pursuit® Camo

PLOW



SPORTSMAN® 570 SP
Magnetic Gray Metallic

BUILD YOUR SPORTSMAN®

WINCHES

- Polaris® PRO HD 1,588 kg Winch 2882242
- Polaris® HD 1,588 kg Winch 2880434
- Polaris® HD 1,134 kg Winch 2880432

PROTECTION

- Front Brushguard 2879714
- Rear Brushguard 2879715
- Ultimate Series - Farm & Ranch Front Guard 2882301

RACKS

- Ultimate Series - Front Rack Extender 10 cm 2879716
- Ultimate Series - Rear Rack Extender 10 cm 2879717
- Tough Rack - Front 2882321
- Tough Rack - Rear 2882322
- Yukon Adventure Rack 2882084

COMFORT

- Throttle/Thumb Warmer 2877364
- Hand Warmers 2877363
- Handguards - Indy Red 2876845
- Handguards - Black 2876846
- Handguards - White 2876883
- Handguard Mount 2879380
- Handlebar Mounted Mirrors 2877222
- Lock & Ride® Sportsman® Backrest 2879887
- Waterproof Bluetooth® Audio 2880458

STORAGE

- Lock & Ride® Ultimate Series Rear Cargo Box 2882882
- Semi-rigid Touring Cargo Bag 2877220

WINDSHIELDS

- Sportsman® Windshield Tall 2880539-409
- Sportsman® Windshield Mid - Black 2880540-070
- Sportsman® Windshield Mid - Smoke 2880540-412
- Sportsman® Windshield Low - Black 2880541-070

DO MORE

- Rigid® & Pro Armor® Lighting P. 46
- Plows P. 44
- Hunt P. 48
- Wheels & Tires P. 38

SPORTSMAN[®] 570 • 450



SPORTSMAN[®] 570 SP
Magnetic Gray Metallic



SPORTSMAN[®] 450 H.D.
Sage Green

WINCHES

POLARIS[®] PRO HD 1,588 KG WINCH TOP SELLER

» 2882242

TOURING 570 SP '15-18, TOURING 570 '14-19, 6X6 570 '17-19,
570 X2 '15-19, 570 SP '15-19, 570 '14-19, 450 H.O. '16-19



INDUSTRY 1ST TECHNOLOGY

RAPID ROPE RECOVERY



LEARN MORE ON P. 10

BRUSHGUARDS

SPORTSMAN[®] 570 / 450 H.O. BRUSHGUARD TOP SELLER

- Durable black powdercoating for long-lasting, scratch-resistant finish
- Integrated mounting location for easy installation and accessory lighting



B FRONT BRUSHGUARD

» 2879714

TOURING 570 SP '15-18, TOURING 570
'14-19, 6X6 570 '17-19, 570 X2 '15-19,
570 SP '15-19, 570 '14-19, 450 H.O. '16-19

REAR BRUSHGUARD

» 2879715

TOURING 570 SP '15-18,
TOURING 570 '14-19,
570 SP '15-19, 570 '14-19,
450 H.O. '16-19



C ULTIMATE SERIES – FARM & RANCH FRONT BRUSHGUARD

- Includes front receiver for additional functionality

» 2882301

TOURING 570 '14-19, 6X6 570 '17-19,
570 X2 '15-19, 570 SP '19, 570 '14-19,
450 H.O. '19
DOES NOT FIT 570 SP MODELS

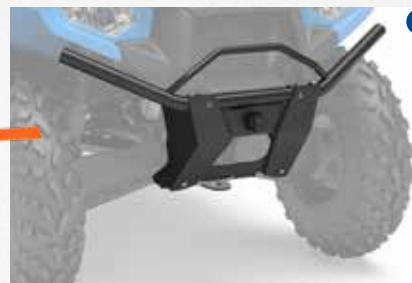

RACKS

ULTIMATE SERIES RACK EXTENDER 10 CM TOP SELLER

FRONT

» 2879716

TOURING 570 SP '15-18, TOURING 570 '14-19, 6X6 570 '17-19, 570 X2 '15-19,
570 SP '15-19, 570 '14-19, 450 H.O. '16-19

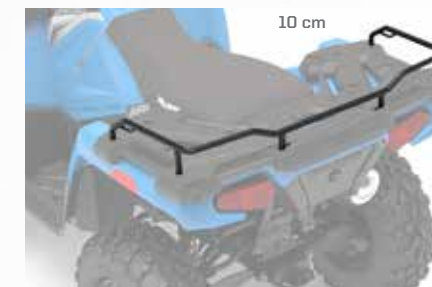

REAR D

» 2879717

570 SP '15-19, 570 '14-19, 450 H.O. '16-19

SPORTSMAN[®] 570/450 H.O. TOUGH RACK

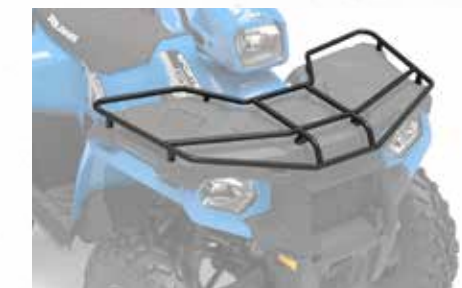

FRONT E

» 2882321

TOURING 570 '14-19, 6X6 570 '17-19,
570 X2 '15-19, 570 SP '15-19,
570 '14-19, 450 H.O. '16-19



REAR F

» 2882322

570 SP '15-19, 570 '14-19, 450
H.O. '16-19

LOCK & RIDE

YUKON ADVENTURE RACK

- Adds increased storage volume by allowing you to increase storage height securely

» 2882084

6X6 570 '17-19



NEED A PLOW? SEE PAGE 38

SPORTSMAN[®] 570 • 450



SPORTSMAN[®] 450 H.O. EPS
Indy Red



SPORTSMAN[®] 570 EPS Utility Edition
Ghost Gray

COMFORT



HAND WARMERS TOP SELLER

» 2877363
ALL SPORTSMAN[®] MODELS



THROTTLE/THUMB WARMER

» 2877364
ALL SPORTSMAN[®] MODELS

WATERPROOF BLUETOOTH[®] AUDIO

- Kit includes four mounting configurations
- Mounts easily to the handlebars or roll cage or fits in your dashboard storage area
- IPX4 -rated for water and dust resistance
- Internal LiPo rechargeable battery provides 12 hours of music between charges

» 2880458
ALL SPORTSMAN[®] & POLARIS ACE[®] MODELS EXCEPT YOUTH



HANDGUARDS

COLORS

■ BLACK	2876846
□ BRIGHT WHITE	2876883
■ INDY RED	2876845

- Handguard Mount (2879380) is required when installing Polaris Handguards
- Does not fit with windshield fairing or handlebar-mounted mirrors

» 2879380 • MOUNT
ALL SPORTSMAN[®] MODELS EXCEPT YOUTH

STORAGE



HANDLEBAR-MOUNTED MIRRORS TOP SELLER

- For added safety on or off the trail
- Sold as a pair
- Does not fit with windshield fairing or handguards

» 2877222
ALL SPORTSMAN[®] MODELS EXCEPT YOUTH

LOCK & RIDE SPORTSMAN[®] BACKREST

» 2879887
570 SP '15-19, 570 '14-19, 450 H.O. '16-19
Does not fit with K-CARGO BOX, REAR, LOCK&RIDE[®] (2882882)



LOCK & RIDE SPORTSMAN[®] ULTIMATE SERIES REAR CARGO BOX

- Increase your ATV storage with an extra 94.6 liters of capacity
- Store two full-size helmets.

» 2882882
XP 1000 '17-19, 850/850 SP '17-19, 570 SP '15-19, 570 '14-19, 450 H.O. '16-19
Cargo Box will not fit when Utility Rack is installed.



SEMI-RIGID TOURING CARGO BAG

- Large-capacity, heavy-duty vinyl bag
- Three zippered openings, removable dividers
- Attaches to rack with Velcro[®] straps

» 2877220
TOURING 570 '14-19

SPORTSMAN[®] 570 · 450



SPORTSMAN[®] Touring 570 EPS
Velocity Blue



SPORTSMAN[®] 6x6 Big Boss 570 EPS
Sage Green

WINDSHIELDS



Tall 19.25" (48.9 cm) Clear

Mid 15.5" (39.4 cm) Black

Mid 15.5" (39.4 cm) Smoke

Low 9.5" (24.1 cm) Black

LOCK & RIDE[™] SPORTSMAN[®] WINDSHIELDS **A**

- Windshield installs on the ATV in seconds without tools with its Lock & Ride[™] technology. It can also be removed in seconds without tools.
- Lock & Ride[™] mounts allow a rider to adjust the height and angle of the windshield.
- Poly windshields are flexible, impact-resistant, and provide long-term value over the life of your machine.
- Three heights available for whatever coverage you prefer
- Does not work with handguards

TOP SELLER

SIZE	COLOR	PART #
TALL 19.25" (48.9 CM)	CLEAR	2880539-409
MID 15.5" (39.4 CM)	BLACK	2880540-070
MID 15.5" (39.4 CM)	SMOKE	2880540-412
LOW 9.5" (24.1 CM)	BLACK	2880541-070

TOURING 570 '18-19, 570 X2 '18-19, 570 SP '15-19, 570 '18-19, 450 H.O. '18-19

DO MORE

LIGHTING SEE P. 40



HUNT SEE P. 42



PLOWS SEE P. 38



WHEELS & TIRES SEE P. 32



TRAIL



SPORTSMAN® 850 SP
White Lightning

WORK



SPORTSMAN® 850
Titanium Gray

XP® 1000 • 850 SPORTSMAN®

MAKE IT YOURS

WORK HARD AND GET IT DONE with Polaris Engineered™ Accessories for your Sportsman®. Start with the ultimate in ATV performance and comfort, then add in lighting, wheels, tires, a winch, Glacier® plows and more. Find everything you need to outfit your trusted partner for the task at hand.

HUNT



SPORTSMAN XP® 1000
Polaris® Pursuit® Camo

PLOW



SPORTSMAN XP® 1000
Radar Blue

BUILD YOUR SPORTSMAN® WINCHES

- Polaris® PRO HD 1,588 kg Winch 2882241
- Polaris® HD 1,588 kg. Winch 2880435
- Polaris® HD 1,134 kg Winch 2880433

RACKS

- Ultimate Series - Front Rack Extender 10 cm 2882022
- Ultimate Series - Rear Rack Extender 10 cm 2882023
- Ultimate Series - Front Rack Extender 18 cm 2882024
- Ultimate Series - Rear Rack Extender 18 cm 2882025
- Sportsman Touring XP® - Front Rack Extender 2879890
- Ultimate Series - Steel Rack - Front 2883257
- Ultimate Series - Steel Rack - Rear 2883258
- Ultimate Series - Movable Tie-Down Points 2882270

PROTECTION

- Ultimate Series - Front Bumper 2882020
- Ultimate Series - Rear Bumper 2882583
- Ultimate Series - Body Armor 2882090
- Sportsman Touring XP® Brushguard - Front 2878709
- Sportsman Touring XP® Brushguard - Rear 2878324

STORAGE

- Lock & Ride® Ultimate Series Rear Cargo Box 2882882
- Ultimate Series - ReadyPack 2882271
- Ultimate Series - Rear Cargo Hold Bag 2882303
- Front Cargo Box 2877951
- Rear Storage Boxes 2878000

WINDSHIELDS

- Ultimate Series Windshield Tall View 2882152
- Ultimate Series Windshield Mid View 2882151
- Ultimate Series Windshield Low View 2882150
- Ultimate Series Windshield Tall View Hard Coat 2881161
- Ultimate Series Windshield Fairing 2882512
- Ultimate Series Windshield Fairing Bag 2882454
- Sportsman® Windshield Tall 2880539-409
- Sportsman® Windshield Mid - Black 2880540-070
- Sportsman® Windshield Mid - Smoke 2880540-412
- Sportsman® Windshield Low - Black 2880541-070

COMFORT

- Handlebar-Mounted Mirrors 2877222
- Hand Warmers 2877363
- Throttle/Thumb Warmer 2877364
- Waterproof Bluetooth® Audio 2880458
- Handguards - Indy Red 2876845
- Handguards - Black 2876846
- Handguards - White 2876883
- Handguard Mount 2879380

SPORTSMAN[®] XP 1000 • 850



SPORTSMAN XP[®] 1000
Radar Blue



SPORTSMAN[®] 850 SP
White Lightning

WINCHES

POLARIS[®] PRO HD 1,588 KG WINCH TOP SELLER

» 2882241

XP 1000/850 HIGH LIFTER '16-19, XP 1000 '15-19, TOURING XP 1000 '15-19, TOURING 850 SP '15-19, SCRAMBLER XP[®] 850 '14-19, SCRAMBLER XP[®] 1000 '14-18, 850/850 SP '12-19



LEARN MORE ON P. 10

A POLARIS[®] HD 1,588 KG WINCH TOP SELLER

» 2880435

XP 1000/850 HIGH LIFTER '16-19, XP 1000 '15-19, TOURING XP 1000 '15-19, TOURING 850 SP '15-19, SCRAMBLER XP[®] 850 '14-19, SCRAMBLER XP[®] 1000 '14-18, 850/850 SP '12-19



POLARIS[®] HD 1,134 KG WINCH TOP SELLER

» 2880433

XP 1000/850 HIGH LIFTER '16-19, XP 1000 '15-19, TOURING XP 1000 '15-19, TOURING 850 SP '15-19, SCRAMBLER XP[®] 850 '14-19, SCRAMBLER XP[®] 1000 '14-18, 850/850 SP '12-19



NEED A PLOW? SEE PAGE 38

RACKS

ULTIMATE SERIES RACK EXTENDER 10 CM

FRONT

» 2882022

XP 1000 '17-19, 850/850 SP '17-19



REAR **B**

» 2882023

XP 1000 '17-19, 850/850 SP '17-19
Fits with Rear Cargo Box (2882882)



ULTIMATE SERIES RACK EXTENDER 18 CM

C FRONT

» 2882024

XP 1000 '17-19, 850/850 SP '17-19

REAR
» 2882025
XP 1000 '17-19, 850/850 SP '17-19
Does not fit with (2882882)



SPORTSMAN XP[®] TOURING FRONT RACK EXTENDER

» 2879890

TOURING XP 1000 '15-19, TOURING 850 SP '15-19

BRUSHGUARDS

SPORTSMAN[®] STEEL RACK

FRONT

» 2883257

XP 1000 '17-19, 850/850 SP '17-19



REAR

» 2883258

XP 1000 '17-19, 850/850 SP '17-19



D MOVEABLE TIE-DOWN POINTS

» 2882270
(FRONT & REAR - SOLD IN PAIRS)

XP 1000 '17-19, 850/850 SP '17-19



SPORTSMAN[®] ULTIMATE SERIES BUMPER TOP SELLER

• Quick installation to the integrated mounting tubes on the vehicle using wedge-style expansion anchor mounts

• Attach the Body Armor to the front bumper to provide the ultimate protection for the front fenders

» 2882020 • FRONT
XP 1000 '17-19, 850/850 SP '17-19

» 2882583 • REAR
XP 1000 '17-19, 850/850 SP '17-19



SPORTSMAN[®] ULTIMATE SERIES -BODY ARMOR

• Securely mounts to Ultimate Series Sportsman XP[®] Front Bumper (2882020)

• Comes as pair

» 2882090
XP 1000 '17-19, 850/850 SP '17-19



SPORTSMAN TOURING XP[®] BRUSHGUARD

• Adds heavy-duty protection and a custom look

» 2878709

TOURING XP 1000 '15-19, TOURING 850 SP '15-19

» 2878324 • REAR

TOURING XP 1000 '15-19, TOURING 850 SP '15-19

SPORTSMAN[®] XP 1000 • 850



SPORTSMAN[®] TOURING 850 SP
Silver Pearl



SPORTSMAN XP[®] 1000
Radar Blue

STORAGE



LOCK & RIDE[®] ULTIMATE SERIES REAR CARGO BOX **TOP SELLER**

- Increase your ATV storage with an extra 94.6 liters of capacity
- Store two full-size helmets.

» 2882882

XP 1000 '17-19, 850/850 SP '17-19, 570 SP '15-19, 570 '14-19, 450 H.O. '16-19
Does not fit with utility rack installed



ULTIMATE SERIES - READYPACK

- Keep your trail essentials at the ready with this easy-to-access, weather-resistant storage compartment

» 2882271

XP 1000 '17-19, 850/850 SP '17-19



ULTIMATE SERIES REAR CARGO HOLD BAG

- Upgrade your stock rear storage component with this removable, divided storage bag

» 2882303

XP 1000 '17-19, 850/850 SP '17-19



LOCK & RIDE[®] FRONT CARGO BOX **A**

» 2877951

TOURING XP 1000 '15-19, TOURING 850 SP '15-19
The Front Rack Extender cannot be installed at the same time as the storage box



LOCK & RIDE[®] REAR STORAGE BOXES **B**

» 2878000

TOURING XP 1000 '15-19, TOURING 850 SP '15-19
Slight interference with Sportsman[®] Touring 550/850 '11-14 passenger handles

WINDSHIELDS

SPORTSMAN[®] ULTIMATE SERIES WINDSHIELDS

Fairing required to add your preferred windshield or storage bag.

WINDSHIELD FAIRING

- Customizable system based on your style and protection needs
- Run just the fairing or add any of the windshields listed to the right
- Does not work with handguards or handlebar mounted mirror

» 2882512

XP 1000 '17-19, 850/850 SP '17-19

WINDSHIELD FAIRING BAG

» 2882454

XP 1000 '17-19, 850/850 SP '17-19



TALL VIEW

» 2882152

XP 1000 '17-19, 850/850 SP '17-19

TALL VIEW HARD COAT

» 2881161

XP 1000 '17-19, 850/850 SP '17-19

MID VIEW

» 2882151

XP 1000 '17-19, 850/850 SP '17-19

LOW VIEW

» 2882150

XP 1000 '17-19, 850/850 SP '17-19



EASY TO CHANGE WINDSHIELDS WITH 6-DART INSTALL

Our fairing system allows for changing out the windshield quickly and easily. Simply remove the six dart-type fasteners and swap out the windshield.



Tall 19.25" (48.9 cm) Clear

Mid 15.5" (39.4 cm) Black

Low 9.5" (24.1 cm) Black

Mid 15.5" (39.4 cm) Smoke

LOCK & RIDE[®] SPORTSMAN[®] WINDSHIELDS **C**

- Windshield installs on the ATV in seconds without tools with its Lock & Ride[®] technology. It can also be removed in seconds without tools.
- Lock & Ride[®] mounts allow a rider to adjust the height and angle of the windshield.
- Poly windshields are flexible, impact-resistant, and provide long-term value over the life of your machine.
- Three heights available for whatever coverage you prefer
- Does not work with handguards

TOP SELLER

SIZE	COLOR	PART #
TALL 19.25" (48.9 CM)	CLEAR	2880539-409
MID 15.5" (39.4 CM)	BLACK	2880540-070
MID 15.5" (39.4 CM)	SMOKE	2880540-412
LOW 9.5" (24.1 CM)	BLACK	2880541-070

XP 1000 '15-16, TOURING XP 1000 '15-19, TOURING 850 SP '15-19, TOURING 570 SP '15-17, 850/850 SP '09-16, 570 SP '15-19, 570 '18-19, 570 6X6 '17-19, 450 H.O. '18-19

SPORTSMAN[®] XP 1000 · 850



SPORTSMAN[®] TOURING XP 1000
Rusty Maroon

SCRAMBLER[®] XP 1000 · 850



SCRAMBLER[®] 850
Ghost Gray

COMFORT



HANDGUARDS

COLORS

■ BLACK	2876846
□ BRIGHT WHITE	2876883
■ INDY RED	2876845

- Handguard Mount (2879380) is required when installing Polaris Handguards
- Does not fit with windshield fairing or handlebar-mounted mirrors

» 2879380 • MOUNT

ALL SPORTSMAN[®] MODELS EXCEPT YOUTH

WATERPROOF BLUETOOTH[®] AUDIO

- Kit includes four mounting configurations
- Mounts easily to the handlebars or roll cage or fits in your dashboard storage area
- IPX4-rated for water and dust resistance
- Internal LiPo rechargeable battery provides 12 hours of music between charges



» 2880458

ALL SPORTSMAN[®] & POLARIS ACE[®] MODELS EXCEPT YOUTH MODELS

A HANDLEBAR-MOUNTED MIRRORS **TOP SELLER**

- For added safety on or off the trail
- Does not work with windshield fairing

» 2877222

ALL SPORTSMAN[®] MODELS EXCEPT YOUTH

HAND WARMERS **TOP SELLER**

» 2877363

ALL SPORTSMAN[®] MODELS

THROTTLE/THUMB WARMER

» 2877364

ALL SPORTSMAN[®] MODELS



DO MORE

LIGHTING

SEE P. 40



PLOWS

SEE P. 38



HUNT

SEE P. 42



WHEELS & TIRES

SEE P. 32



WINCH



POLARIS[®] **TOP SELLER** PRO HD 1,588 KG WINCH **NEW**

» 2882241

XP 1000/850 HIGH LIFTER '16-19, XP 1000 '15-19, TOURING XP 1000 '15-19, TOURING 850 SP '15-19, SCRAMBLER XP[®] 850 '14-19, SCRAMBLER XP[®] 1000 '14-18, 850/850 SP '12-19



A POLARIS[®] **TOP SELLER** HD 1,588 KG WINCH

» 2880435

XP 1000/850 HIGH LIFTER '16-19, XP 1000 '15-19, TOURING XP 1000 '15-19, TOURING 850 SP '15-19, SCRAMBLER XP[®] 850 '14-19, SCRAMBLER XP[®] 1000 '14-18, 850/850 SP '12-19



POLARIS[®] **TOP SELLER** HD 1,134 KG WINCH

» 2880433

XP 1000/850 HIGH LIFTER '16-19, XP 1000 '15-19, TOURING XP 1000 '15-19, TOURING 850 SP '15-19, SCRAMBLER XP[®] 850 '14-19, SCRAMBLER XP[®] 1000 '14-18, 850/850 SP '12-19

RACKS



LARGE REAR RACK

» 2879139

SCRAMBLER XP[®] 850 '14-19, SCRAMBLER XP[®] 1000 '14-18
Not compatible with Ogio[®] Scrambler[®] Bag (2879925)

STORAGE



B OGIO[®] SCRAMBLER[®] BAG

» 2879925

SCRAMBLER XP[®] 850 '14-19, SCRAMBLER XP[®] 1000 '14-18

PROTECTION



FRONT BRUSHGUARD

» 2879136

SCRAMBLER XP[®] 850 '14-19, SCRAMBLER XP[®] 1000 '14-18
Replaces existing lower bumper will not work together



REAR BASH GUARD

» 2879138

SCRAMBLER XP[®] 850 '14-19, SCRAMBLER XP[®] 1000 '14-18



POLARIS® SPORTSMAN® AUDIO & ESSENTIAL ACCESSORIES



MTX® OVERHEAD AUDIO POD POLARIS ACE

- Bluetooth® connectivity for wireless audio
 - USB port for charging mobile devices in waterproof storage locker
 - LCD display shows audio information; convenient LED lights shine toward rider
 - Auxiliary connection through headphone jack
 - Dual 6" speakers and tweeters that direct sound toward rider
 - Installs in less than 15 minutes; includes all wiring
 - Durable, sealed, hard plastic black housing
 - Can be used with a roof and windshield; not compatible with Overhead Storage Bag
- » 2879703
ALL POLARIS ACE® MODELS



SOUND BAR 4 POLARIS ACE

- Dual mid-range/mid-bass speaker and two dedicated tweeters
 - Integrated, self-powered amplifier for easy installation
 - Bluetooth® or wired audio input with variable output
 - Large, easy-to-use external controls
 - Aluminum, black finish housing with low profile, clamp-on mounts
 - Includes mounts, audio bar, waterproof connections, and instructions
- » 2881230
ALL POLARIS ACE® MODELS
Requires Audio Harness (2882280)
» 2882280



WATERPROOF BLUETOOTH® AUDIO POLARIS ACE SPORTSMAN

- Kit includes four mounting configurations
 - Mounts easily to the handlebars or roll cage or fits in your dashboard storage area
 - IPX4 -rated for water and dust resistance
 - Internal LiPo rechargeable battery provides 12 hours of music between charges
- » 2880458
ALL SPORTSMAN® & POLARIS ACE® MODELS EXCEPT YOUTH



SPORTSMAN® BOOM SPRAYER - 56.8 L
» 2882266
ALL SPORTSMAN® MODELS EXCEPT TOURING



RIDE & REPAIR ESSENTIALS KIT

- 12-volt DC portable air compressor
 - Tire repair kit with 6 plugs
 - Basic first-aid kit with bandages, scissors, safety pins, and more
 - 12-volt jumper cables
 - Duct tape - 300mm x 1 roll
 - Zip ties - 150mm length
 - Electrical tape
 - Ratchet strap - 50mm
 - Microfiber cloth
 - Carry bag
- » 2881207

LICENSE PLATE KIT

- Includes numbers & letters
- » 2873270
ALL SPORTSMAN® MODELS

TRAILERING AND RECOVERY STRAPS



NEW
5 CM X 9 M RECOVERY STRAP

- Heavy duty webbing
 - 8165 kg Breaking Strength / 4082 kg Max. Vehicle Weight
 - Built in strap wrap - easy storage
 - Loops sewn in to webbing
 - 1 Strapbag
- » 2884033



NEW
5 CM X 6 M 4536 KG RATCHET STRAP

- Heavy duty webbing
 - 4536 kg Maximum Load / 1497 kg Working Load
 - Floating D-Rings
 - Double J-Hooks
- » 2884032



NEW
3.8 CM X 4.6 M 2495 KG RATCHET STRAP

- Heavy duty webbing
 - 2495 kg Maximum Load / 831 kg Working Load
 - 2 Pack
- » 2884031



SHOCKSTRAP

- » 2883295 • 3.8 CM X 2.1 M (2 PACK)
- » 2883296 • 3.8 CM X 4.6 M (2 PACK)

QUICKTAP BATTERY POSTS

- Easy-to-access terminal posts give you quick access to the battery power
 - Ideal for charging your battery, powering a temporary accessory, or when you need to offer an unexpected jump-start
 - Connection posts feature covers to protect terminals when not in use
- » 2882110 •
X2 570 '15-19, TOURING 570 '14-19, 570 SP '15-19, 570 '14-19, 570 6X6 '17-19

PRO ARMOR®

Each wheel and tire Pro Armor® designs for off-road vehicles performs perfectly in the intended environment for its intended use. Developed, tested, and produced in partnership so you can tackle the terrain ahead with Polaris®.



TIRES

8 OR 10-PLY RATED

- Pro Armor® builds the toughest tires
- Higher ply ratings mean added protection

INNOVATION

DUAL-DUROMETER LUGS (Crawler XG & Attack 2.0)

- Firm durometer rubber on base of lug for stability
- Soft durometer rubber on top of lug for sticky grip

DUAL COMPOUND TREAD (Dual-Threat)

- Firm durometer rubber on center of tread for long wear life
- Soft durometer rubber on shoulders of tread for superior grip



TRIPLE-BELTED SIDEWALLS

- Sidewalls are the most vulnerable puncture area of any off-road tire
- Pro Armor® makes tires with extra protection exactly where it's needed most - the sidewall

Sidewall puncture force vs. competition independently tested at Smithers Rapra (smithers.com). The results speak for themselves.

PRO ARMOR® ATTACK	157.4 kg
MAXXIS® BIGHORN 2.0	73.5 kg
MAXXIS® BIGHORN	68 kg

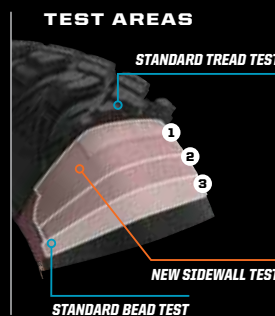

TORTURE-TESTED TOUGH SIDEWALLS

4,828+ km RATED

Pile on the kilometers with Pro Armor® tires. Every tire is designed and constructed with longevity in mind. With ratings of 4,828 km and beyond, you are assured long life and performance.

KNOW YOUR TIRES

DIMENSIONS
28" x 9" R14
TIRE HEIGHT | TIRE WIDTH | WHEEL DIAMETER

TREAD DEPTH
Deeper tread = more grip in all conditions

PADDLE DEPTH
Increases grip and performance in the sand

WEIGHT
A lighter tire makes for improved vehicle performance

SIDEWALL BELTS
Increase your resistance to sidewall punctures

PLY RATING
Indicates the puncture-resistance of a tire

LOAD RATING
Tires with higher load ratings can handle more weight

KNOW YOUR TERRAIN

TRAIL
• Tread patterns optimized for extreme traction
• Ideal for both hard pack and loose trail

DUNES
• Paddles provide traction and durability in soft sand
• Built to float on top of sand

ROCK
• Flexible "grippy" tread
• Aggressive side bite

UTILITY
• Industry leading anti-puncture side walls
• Purpose-built, long lasting tread patterns

DESERT
• Provides traction and durability
• Built to perform in hard sand, jagged rocks or any other extreme terrain

SNOW
• Handles extreme cold
• Holds shape and provides traction

MUD
• Extra deep treads
• Self-cleaning lugs

Exclusively at Polaris® Authorized Dealers

TRAIL



FRONT

REAR

PRO ARMOR® DUAL-THREAT

Engineered with dual-compound technology and radial construction to offer revolutionary off-road performance in all terrains. The lateral-grip compound on the outer edges of the tire has a softer durometer rubber for cornering performance and superior grip. The long-wearing compound in the middle of the tire has harder durometer rubber for increased traction during acceleration, straight line stability, and overall longer tread life.

14" 26" x 9" R14 • FRONT • 5416340
26" x 11" R14 • REAR • 5416341

	TREAD DEPTH	WEIGHT	PLY RATING	SIDEWALL BELTS	LOAD RATING
FRONT	16mm	12.2 kg	10	3	413 kg
REAR		13.6 kg			499 kg



WHEEL SIZE

14"

UTILITY

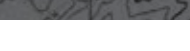

WHEEL SIZE

14" 12"

WHEEL SIZE

14" 12"

WHEEL SIZE

12"



PRO ARMOR HARVESTER

- All-around workhorse with tread life of 8,046 kilometers
- Tread pattern designed to withstand anything from the farmyard and to the pastures to the trail
- With 10-Ply, it can carry the load day in and day out

14" 27" x 10" R14 • FRONT/REAR • 5415965
12" 26" x 8" R12 • FRONT • 5416396
12" 26" x 10" R12 • REAR • 5415966



PRO ARMOR PRESERVE™

- Turf-friendly for areas where low impact from tire tread is needed
- Exceptionally quiet-running tire
- Low impact tire

14" 27" x 10" R14 • FRONT/REAR • 5416348
12" 26" x 8" R12 • FRONT • 5416403
12" 26" x 10" R12 • REAR • 5416402



PRO ARMOR XD-K

- 26" Aramid fiber-belted tire can tackle any terrain
- Unique full-face tread design
- Harder durometer lugs promotes for extended wear increasing tire life

12" 26" x 9" R12 • FRONT • 5415756
12" 26" x 11" R12 • REAR • 5415757



FRONT / REAR

PRO ARMOR® ATTACK

- The best all-purpose tire for all-season traction in any terrain
- Unique full-face tread design
- Harder durometer lugs promote extended wear, increasing tire life

14" 26" x 9" R14 • FRONT • 5415613
26" x 11" R14 • REAR • 5415614

	TREAD DEPTH	WEIGHT	PLY RATING	SIDEWALL BELTS	LOAD RATING
FRONT	23mm	12.7 kg	8	3	413 kg
REAR		14.5 kg			599 kg



WHEEL SIZE

14"

	TREAD DEPTH	WEIGHT	PLY RATING	SIDEWALL BELTS	LOAD RATING		TREAD DEPTH	WEIGHT	PLY RATING	SIDEWALL BELTS	LOAD RATING		TREAD DEPTH	WEIGHT	PLY RATING	SIDEWALL BELTS	LOAD RATING		
26"	FRONT	16mm	10.9 kg	10	3	388 kg	26"	FRONT	10.9 kg	10	3	388 kg	26"	FRONT	31.7mm	12.7 kg	8	3/1 Aramid	424 kg
	REAR							14.5 kg						599 kg					
27"	FRONT/REAR	16mm	14.5 kg	10	3	599 kg	27"	FRONT/REAR	12.7 kg	10	3	599 kg							

SNOW



FRONT / REAR

PRO ARMOR® WHITEOUT

- Extra wide tires for flotation in snow
- Tread pattern designed for superior snow traction with limited digging

14" 27" x 14" R14 • FRONT/REAR • 5416032

	TREAD DEPTH	WEIGHT	PLY RATING	SIDEWALL BELTS	LOAD RATING
FRONT	16mm	12.2 kg	8	3	424 kg
REAR					



WHEEL SIZE

14"

MUD



FRONT

REAR

PRO ARMOR® DAGGER

- From the trails to the pits, this tire gets you through it all
- Deep, self-cleaning lug and wide tire design for exceptional mud pit performance
- Rounded profile and full lug pattern for on-trail comfort

14" 27" x 9" R14 • FRONT • 5415617
14" 27" x 11" R14 • REAR • 5415618

	TREAD DEPTH	WEIGHT	PLY RATING	SIDEWALL BELTS	LOAD RATING
27"	FRONT	14.5 kg	8	3	499 kg
	REAR	18 kg			531 kg



WHEEL SIZE

14"

WHEELS



A AMPLIFY

FRONT:	Weight: 5.9 kg	Offset: -9	
	Load Rating: 408 kg		
REAR:	Weight: 6.4 kg	Offset: +4	
	Load Rating: 590 kg		
ACCENT:	FRONT	14" x 7"	1522956-266
	REAR	14" x 8"	1522957-266
MATTE BLACK:	FRONT	14" x 7"	1522956-458
	REAR	14" x 8"	1522957-458

B BUCKLE

FRONT:	Weight: 5.8 kg	Offset: +4	
	Load Rating: 408 kg		
REAR:	Weight: 6.1 kg	Offset: -9	
	Load Rating: 590 kg		
ACCENT:	FRONT	14" x 7"	1522544-266
	REAR	14" x 8"	1522545-266
MATTE BLACK:	FRONT	14" x 7"	1522544-458
	REAR	14" x 8"	1522545-458

C COMBAT (BEADLOCK RINGS INCLUDED)

FRONT/REAR:	Weight: 7.3 kg	Offset: +38	
	Load Rating: 726 kg		
ACCENT:	FRONT/REAR	14" x 7"	1523284
MATTE BLACK:	FRONT/REAR	14" x 7"	1523283

D REBLR (BEADLOCK RINGS SOLD SEPARATELY)

FRONT:	Weight: 5.9 kg	Offset: +4	
	Load Rating: 408 kg		
REAR:	Weight: 6.6 kg	Offset: -9	
	Load Rating: 590 kg		
ACCENT:	FRONT	14" x 7"	1522238-458
	REAR	14" x 8"	1522239-458

E SHACKLE

FRONT:	Weight: 5.9 kg	Offset: +4	
	Load Rating: 408 kg		
REAR:	Weight: 6.4 kg	Offset: -9	
	Load Rating: 590 kg		
ACCENT:	FRONT	14" x 7"	1522546-266
	REAR	14" x 8"	1522547-266
MATTE BLACK:	FRONT	14" x 7"	1522546-458
	REAR	14" x 8"	1522547-458

F SIX'R

FRONT:	Weight: 4.8 kg	Offset: +4	
	Load Rating: 408 kg		
REAR:	Weight: 5.7 kg	Offset: -9	
	Load Rating: 590 kg		
MATTE BLACK:	FRONT	14" x 7"	1521507-521
	REAR	14" x 8"	1521508-521
LUSTER:	FRONT	14" x 7"	1521507-410
	REAR	14" x 8"	1521508-410

G SPLIT

FRONT:	Weight: 4.3 kg	Offset: +4	
	Load Rating: 408 kg		
REAR:	Weight: 4.9 kg	Offset: -9	
	Load Rating: 590 kg		
MATTE BLACK:	FRONT	14" x 6"	1522542-458
	REAR	14" x 8"	1522543-458

H WHITEOUT

FRONT:	Weight: 6.6 kg	Offset: -35	
	Load Rating: 363 kg		
REAR:	Weight: 6.6 kg	Offset: -35	
	Load Rating: 363 kg		
MATTE BLACK:	FRONT/REAR	14" x 10"	1522958

2 WAYS TO PURCHASE

INDIVIDUAL WHEELS & TIRES - OR - COMPLETE SETS AS LISTED

Exclusively at Polaris® Authorized Dealers

14" FORGED BEADLOCK RINGS



14" FORGED BEADLOCK RINGS Sold individually	PART #
A Voodoo Blue	1522244-619
B Machined	1522244-266
C White	1522244-133
D Indy Red	1522244-293
E Orange Crush	1522244-589
F Matte Black - Replacement Only used on Combat	1523146-458

WHEEL & TIRE SETS

14"

TRAIL

MUD

UTILITY

SNOW

14" WHEELS	ATTACK 26"	DUAL-THREAT 26"	DAGGER 27"	PRESERVE 27"	HARVESTER 27"	WHITEOUT 27"
○ AMPLIFY Accent	2882390	2883138	2882392	2883208	2882388	
○ AMPLIFY Matte Black	2882391	2883139	2882393	2883209	2882389	
○ BUCKLE Accent	2881335	2883140	2881337	2883203	2882383	
○ BUCKLE Matte Black	2881336	2883141	2881338	2883204	2882384	
○ COMBAT Accent *BEADLOCKS PRE-MOUNTED		2883217				
○ COMBAT Matte Black *BEADLOCKS PRE-MOUNTED		2883216				
○ REBLR Matte Black *BEADLOCKS SOLD SEPARATELY	2881381		2881383			
○ SHACKLE Accent	2881347	2883142	2881349	2883205	2882385	
○ SHACKLE Matte Black	2881348	2883143	2881350	2883206	2882386	
○ SIXR Luster	2881359		2881362			
○ SIXR Matte Black	2881360	2883144	2881363	2883207	2882387	
○ SPLIT Matte Black	2881404	2883145	2881405			
○ WHITEOUT R14 Matte Black						2882382

LUG NUTS

○ LUG NUTS REQUIRED



10MM X 1.25 HEX LUG NUTS

- › 2877385 - 4 HEX LUG NUTS
- › 2877384 - 16 HEX LUG NUTS Sportsman XP®

3/8" - 24 HEX LUG NUTS

- › 2876754 - 4 HEX LUG NUTS
- › 2877409 - 16 HEX LUG NUTS Polaris ACE®, SPORTSMAN® 450/570

REPLACEMENT CAPS

POLARIS® CAPS

LUSTER	All WHEELS EXCEPT WYDE & HEXLR	1521509-410 •
MATTE BLACK		1521509-521 •

PRO ARMOR® CAPS

LUSTER	All WHEELS EXCEPT WYDE & HEXLR	5453209-410 •
MATTE BLACK		5453209-458 •



COLBY VALVE SHORT ULTIMATE VALVE - 2 PACK

› 2883292



COLBY VALVE EMERGENCY VALVE - 2 PACK

› 2883293

ALL-TERRAIN TRACTION

It's tough to make Sportsman® and Polaris ACE® even more versatile than they already are. But with a set of Prospector Pro® Tracks, you'll do just that. Tread through deep snow without concern.

Polaris®-specific gearing provides 1:1 ratio to:

- Minimize track slip, providing better climbing ability and improved traction in deep snow
- Improve top speed over prior models by approximately 5%
- Reduce operating RPM for a quieter ride
- Improve driveline durability, which allows vehicle to run at a lower RPM, decreasing engine wear

New front dual stabilizer for improved stability

Polaris® Exclusive optimized hub geometry that minimizes feedback and eases steering effort

Lightweight design provides for better flotation, eases steering effort, and provides better vehicle control

Flexible lug design provides the highest level of deep snow performance by lifting up in deep snow as opposed to digging down



MODELS	TYPE	STEP 1 SELECT A MOUNT	STEP 2 SELECT A KIT
SPORTSMAN® 570 EPS '15-19 SPORTSMAN® 570 SP '15-19 SPORTSMAN® TOURING 570 SP '15-19 SPORTSMAN® X2 570 '15-19	EPS	2879497	2881025
SPORTSMAN XP® 1000 '17-19 SPORTSMAN® 850 SP '18-19	EPS	2882109	2881003
SCRAMBLER® 1000 '15-19 SPORTSMAN® TOURING XP 1000 '15-19 SPORTSMAN® TOURING 850 SP '15-19	EPS	2879457	2881003
SPORTSMAN® 570 '14-19 SPORTSMAN® TOURING 570 '15-19	NON-EPS	2879497	2880020
SCRAMBLER® 850 '13-19 SPORTSMAN® 850 '15-19	NON-EPS	2879457	2879720
SPORTSMAN XP® 1000 '18-19	NON-EPS	2882109	2879720
570 6X6 '17-19	EPS	2882169 Includes Track Mount & Track Kit	

WANT TO PLOW? GLACIER® PRO PLOW TRACK EXTENSION



» 2879719

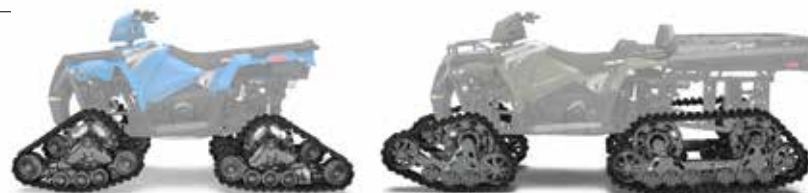

- Plow extension for use when using the prospector pro track system and Glacier® Pro Sportsman® or Polaris ACE® plow system

FOR USE WITH GLACIER® PRO SPORTSMAN® AND POLARIS ACE® PLOW SYSTEMS



WANT TO PLOW? SEE PAGE 44

SPORTSMAN® SNOW TRACTION OPTIONS

TREAD THROUGH SNOW WITH THESE OPTIONS	CONTACT PATCH	TURNING RADIUS
 <p>STOCK TIRES</p>	<p>GOOD</p> 	 <p>354.3 CM</p>
 <p>PRO ARMOR® WHITEOUT</p>	<p>BETTER</p>  <p>MORE SURFACE AREA FOR BETTER FLOTATION ON SNOW</p>	 <p>352.7 CM</p>
 <p>PROSPECTOR PRO® TRACKS</p>	<p>BEST</p>  <p>LESS AGGRESSIVE TREAD DISPLACES SNOW FOR BETTER HANDLING</p>	 <p>445.5 CM</p>

GLACIER®

PLOW SYSTEM

When you have the power of a Glacier® Pro Plow System on your machine, you can truly take command of clearing snow and moving whatever you need to. Find the blade that fits your needs and you'll make quick work of even the heaviest jobs.



BUILD YOUR PERFECT PLOW SYSTEM

***GLACIER**
PLOW SYSTEM

ADD HYDRAULICS



CONTROL FROM THE PALM OF YOUR HAND

Change the angle of the plow blade with the Power Controller.



HYDRAULIC CONTROL FOR EXTREME SNOW REMOVAL

A robust frame and tough blades, combined with the option to add a hydraulic control, allow your Glacier® PRO HD to move serious snow while you remain comfortable. Thanks to Lock & Ride® technology, the PRO HD system allows you to easily add or remove the plow blade without pins or tools.



GLACIER® PRO HD GIVES YOU » 168, 152 or 132 cm Blades » Choice of poly or steel » Ability to add a hydraulic angle system

THE POLARIS ENGINEERED™ ADVANTAGE

INSTALLATION

30 seconds: Drive up, clip in, lock down, and go – the integrated Polaris Engineered™ Glacier® Plow System simplifies plowing.



CONVENIENCE

Lift and angle adjustments can be made from the driver's seat.

ANGLE YOUR BLADE RIGHT FROM YOUR SEAT WITH THE GLACIER® PRO PLOW HYDRAULIC ANGLE SYSTEM



ROBUST FRAME

A plow system is only as strong as its frame, and Polaris Engineered™ plow frames have a wide frame to withstand the rigors of heavy plowing.



DURABILITY

Available in strong stamped steel or corrosion-resistant poly materials, Polaris Engineered™ plow blades cover a large surface area for quick snow removal.

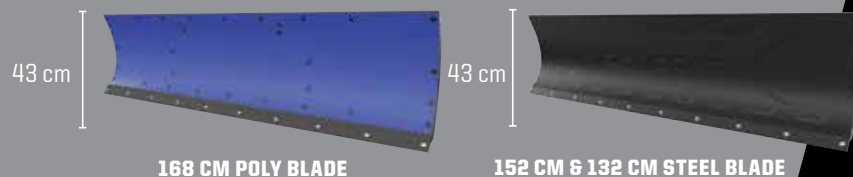

168 CM POLY BLADE

152 CM & 132 CM STEEL BLADE

MODELS	MANDATORY STEPS				OPTIONAL
	STEP 1 SELECT A MOUNT	STEP 2 SELECT A FRAME	STEP 3 SELECT PLOW CONFIGURATION		STEP 4 ADD HYDRAULICS
	MOUNT	FRAME	WINCHES	BLADES	HYDRAULICS
XP 1000 '15-19 850/850 SP '15-19 850/XP 1000 HIGHLIFTER '16-19 TOURING XP 1000 '15-19 TOURING 850 SP '15-19 SCRAMBLER® '15-19	2881423	2879630	Polaris® PRO HD 1588 kg Winch 2882241 Polaris® HD 1588 kg Winch 2880435 Polaris® HD 1134 kg Winch 2880433	168 cm Poly 2880269 152 cm Steel 2879638 132 cm Steel 2879639	Hydraulic Angle System 2879635 Power Controller 2880836 Power Controller Recommended
570 SP '15-19 570 '15-19 570 6X6 '17-19 X2 570 '15-19 TOURING 570 SP '15-19 TOURING 570 '15-19 450 H.O. '16-19 ETX '15	2879633		Polaris® PRO HD 1588 kg Winch 2882242 Polaris® HD 1588 kg Winch 2880434 Polaris® HD 1134 kg Winch 2880432		
570 '14 TOURING 570 '14 500 '12-14 500 H.O. '12-13 TOURING 500 '13 800 '12-14 400 H.O. '12-14	2881424		Polaris® PRO HD 1588 kg Winch 2882243 Polaris® HD 1588 kg Winch 2882106 Polaris® HD 1134 kg Winch 2882105		
POLARIS ACE® 570 SP '14-16 POLARIS ACE® 570 '15-16 POLARIS ACE® '14-16	2879634				
POLARIS ACE® 900 XC '17-19 POLARIS ACE® 570 SP '17 POLARIS ACE® 570 '17-19 POLARIS ACE® 500 '17-19	2882107				

STEP 5 SELECT ACCESSORIES & REPLACEMENT ITEMS

ACCESSORIES & REPLACEMENT ITEMS		
168 cm HD Wear Bar 2879868 168 cm Wear Bar 2879867 152 cm Wear Bar 2877243 132 cm Wear Bar 2877210	168 cm Snow Deflector 2879866 152 cm Snow Deflector 2871808 Skid Shoe 2205071 Shear Pin 2205063	Plow Winch Rope 2878483 • For 1134 & 1588 kg winches Plow Marker 2872726 • Sold in Pairs 25" / 26" Tire Chains 2881422 • Recommended for rear tires only Extension for Tracks 2879719 • Required for track equipped vehicles

NEED TRACKS? SEE PAGE 36

ACCESSORIES

WINCHES

570-450

XP 1000-850

AUDIO & ESSENTIALS

WHEELS & TIRES
TRACKS

PLOW

LIGHTING

HUNT & COOLERS



ADVANCED TECH

RIGID® lights are driven by Aluminum PCB Smart Boards™. 6063-T5 aircraft aluminum extruded housings and Tiger Drylac® UV protection polyester powdercoating. Our lighting is ECE Certified.

EXCLUSIVE OPTICS

RIGID® lights feature impact-resistant polycarbonate lenses for a 100% water/dustproof seal.

RUGGED CONSTRUCTION

Pro Armor® lights are designed to be big and beefy with an aggressive style all their own, and housed in IP67 marine-grade rated UV polyester powdercoating. Our lighting is ECE Certified.

MASSIVELY BRIGHT

Pro Armor® builds bright lights designed for any riding experience. All that power is directed through heat dissipating aluminum for streamlined heat management.

LIGHT BAR TYPES



SR-SERIES PRO

Sleek, powerful, low-profile (under 5 cm tall). Lights extreme distances with low energy usage. Available in 25 cm



D-SERIES PRO

Compact to fit almost anywhere with high output and low energy usage. Available in Driving, Flood & Spot



DUAL-ROW LED LIGHT BARS

The most spread and farthest illumination downrange. Easy to mount. Available in Cube, 25 cm & 51 cm



SINGLE-ROW LED LIGHT BARS

Powerful, compact, low-profile light bars with sleek look. Available in 51 cm



CUBE LED LIGHTS

Small size allows mounting in strategic locations for added lighting. Available in Flood & Spot

LIGHT BAR OPTIONS

OPTICS DRIVING

FLOOD

SPOT

COMBO

OPTICS

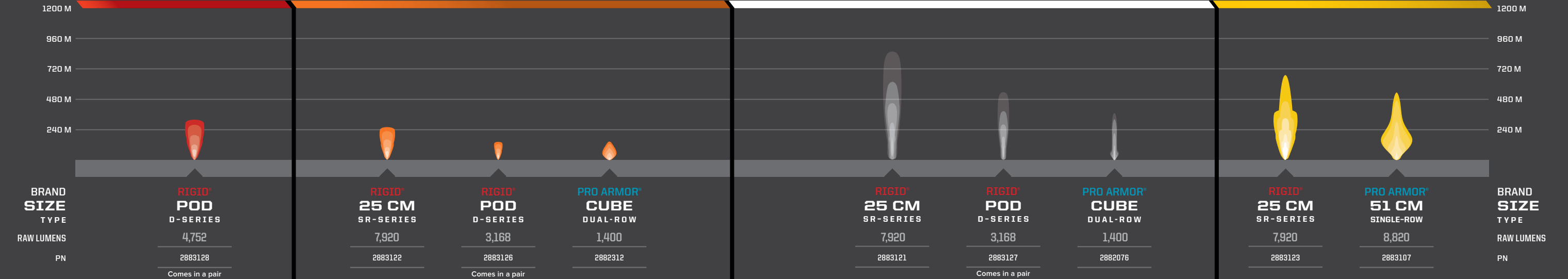

BUILD YOUR VISION

Consider the Optics, Angle & how you will use your vehicle to choose the right light or set of lights.

OPTICS LIGHT ANGLE	ACCENT	DRIVING (45°)	FLOOD (25°)	SPOT (10°)	COMBO (25°/10°)
DRIVING SPEED	All	Slow	Medium	Fast	Medium to Fast
BEAM	Diffused glow	Extra-wide	Wide/Shorter	Concentrated/Long	Inner Spot & Outer Flood
RECOMMENDED MOUNTING	Low/Wheel well	All points	Low &/or rear	High points	All points
TERRAIN & RIDING STYLE	Added style & personalization in any terrain	All riding & utility	Wide-open terrain or trails & utility	Trail & tight conditions	All riding & utility

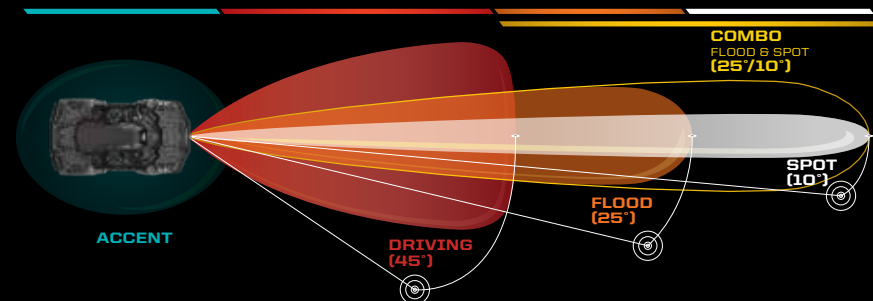

ACCENT LIGHTING



ACCENT LIGHTING KIT

- Durable off-road ready construction that is both dust- and water-resistant
- Features CREE® LED for a long-lasting, brilliant light
- Set includes four LED pods

COLOR LIGHTING KIT

- RED 2880500
- BLUE 2880506

ALL FULL-SIZE SPORTSMAN® MODELS & FULL-SIZE POLARIS ACE®, DOES NOT FIT ACE® 150.

WIRING HARNESSES

LED LIGHT BAR HARNESS

- Control one light with one switch
- » 2882320 ALL SPORTSMAN® MODELS.

LED HARNESS WITH TWO CONNECTORS

- Y-Harness requires 2882320 to control two cubes or two lights with one switch
- » 2879860 ALL SPORTSMAN® MODELS.

PROTECT THE GEAR YOU NEED. LIVE THE LIFE YOU LOVE.

KOLPIN STRONGHOLD® SYSTEM

Polaris® is proud to partner with Kolpin® Outdoors, an industry leader in off-road accessories and the premier name in gun boots and mounts. If you need to secure a firearm, ice fishing rods, an ice auger or a pop-up blind while riding, simply attach the auto-latch mount and choose your case.

IDEAL FOR SCOPED RIFLES, SHOTGUNS AND LONG-BARRELED PISTOLS

KOLPIN STRONGHOLD® PRODUCTS SECURELY PROTECT THE ESSENTIALS WHEN ON THE TRAIL.



STEP 1 CHOOSE YOUR MOUNT

STEP 2 CHOOSE YOUR BOOTS



Includes Transport Case



AUTO-LATCH MOUNT

- Precision angle adjustable for a custom fit
- Provides a quick and secure attachment point

» 2882300 » 2882272

ETX '15, 570 SP '15-19, 570 '14-19, 450 H.O. '16-19 DOES NOT WORK ON 450 UTILITY MODELS

» 2882272

XP 1000 '17-19, 850/850 SP '17-19 DOES NOT FIT IF BODYGUARD BUMPER 2882090 IS INSTALLED

GUN BOOT® XL – TRANSPORT

- Lockable and TSA Approved
- 132.1 cm x 9.5 cm x 26.7 cm

» 2882430

Requires Auto-Latch Mount (2882272 or 2882300)

GUN BOOT® L – IMPACT

- 132.1 cm x 12.1 cm x 23.5 cm

» 2882426

Requires Auto-Latch Mount (2882272 or 2882300)

PISTOL BOOT

- 39.4 cm x 6.4 cm x 21 cm

» 2882429

Requires Auto-Latch Mount (2882272 or 2882300)

ICE AUGER / POP-UP BLIND BOOT

- 116.8 cm L x 31.8 cm W

» 2882427

Requires Auto-Latch Mount (2882272 or 2882300)

ICE ROD BOOT

- 99.1 cm L x 47 cm W x 15.2 cm H

» 2882428

Requires Auto-Latch Mount (2882272 or 2882300)

KOLPIN® RHINO GRIP®

IDEAL FOR BOWS, CROSSBOWS AND UNCASSED LONG GUNS



LOCK & RIDE
RHINO GRIP PRO BY KOLPIN® *NEW*

» 2884119

» 2884109 • STRAP

ALL SPORTSMAN® MODELS (EXCEPT UTILITY EDITIONS & YOUTH)
ALL ACE® MODELS (EXCEPT 150)



LOCK & RIDE
RATCHETING RHINO GRIP® BY KOLPIN®

» 2881157

ALL SPORTSMAN® MODELS (EXCEPT UTILITY EDITIONS & YOUTH)
ALL ACE® MODELS (EXCEPT 150)



LOCK & RIDE
RHINO GRIP XL DOUBLE BY KOLPIN® *NEW*

» 2884120

» 2881621 • STRAP

ALL SPORTSMAN® MODELS (EXCEPT UTILITY EDITIONS & YOUTH)
ALL ACE® MODELS (EXCEPT 150)



LOCK & RIDE
RHINO GRIP XL BY KOLPIN®

» 2881513

» 2881621 • STRAP

ALL SPORTSMAN® MODELS (EXCEPT UTILITY EDITIONS & YOUTH)
ALL ACE® MODELS (EXCEPT 150)

POLARIS® GUN BOOTS BY KOLPIN®

- » BLACK • 2872677
- » MOSSY OAK® BREAK-UP® • 2872677-419

LOCK & RIDE GUN BOOT® MOUNTS

- High-impact case secures firearm over any terrain
- Lock & Ride® system mounts on right side
- Works with Lock & Ride® XL Storage Box, Lock & Ride® Rear Cargo Box, and Rear Rack Extenders

» 2877381

850/XP 1000 '16-19, 850/850 SP '09-16

» 2878001

TOURING XP 1000 '15-19, TOURING 850 SP '15-19

» 2879888

570 SP '15-19, 570 '14-19, 450 H.O. '16-19

» 2881143

POLARIS ACE® 570 '15-19, POLARIS ACE® 500 '17-19

THANKS TO OUR PARTNERS. We would like to thank our partners Browning® and Mathews® for helping to deliver a successful and safe off-road experience when out in the field.



Browning® is a registered trademark of Browning. Mathews® is a registered trademark of Mathews Archery Inc.

Never transport a loaded firearm. Verify firearm is unloaded prior to mounting. Please refer to local laws and regulations regarding the requirements for the legal transport of firearms.

KEEP IT ICE COLD



POLARIS NORTHSTAR® COOLERS can survive just about anything - from extreme heat to a nasty tumble off a vehicle. So when we say ice will stay cold for hours on end and anything inside will stay locked up tight, we mean it.

POLARIS NORTHSTAR® COOLER



- | | | | | |
|---|---|---|--|--|
| 99 LITER
› GRAPHITE • 2883426
› DESERT • 2883392 | 57 LITER
› GRAPHITE • 2883425
› DESERT • 2881259 | 28 LITER
› GRAPHITE • 2883424
› DESERT • 2881315 | 14 LITER <i>NEW</i>
› GRAPHITE • 2883968 | 19 LITER SOFTSIDE
› GRAPHITE • 2883390 |
|---|---|---|--|--|

28, 57 & 99 LITER FEATURES

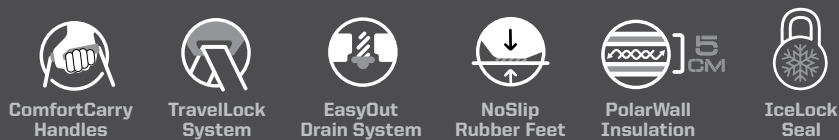

TUMBLERS

- › 887 ML • 2883394
- › 591 ML • 2883393

GRIZZLY TESTED. POLARIS® APPROVED.



This cooler is IGBC-approved, meaning it withstands the power expended by a typical grizzly bear if it was trying to get inside. Seriously, there are experts who know what a grizzly is capable of doing, and they certify that the Polaris Northstar® Cooler can take it.



POLARIS NORTHSTAR® COOLER ACCESSORIES



WIRE BASKET

- › 99 LITER • 2883648 *NEW*
- › 57 LITER • 2882185
- › 28 LITER • 2882438



DIVIDERS

- › 99 LITER • 2883468 *NEW*
COMES WITH ONE DIVIDER
 - › 57 LITER • 2882184
COMES WITH TWO DIVIDERS
 - › 28 LITER • 2882186
COMES WITH ONE DIVIDER
- Divider doubles as a cutting board



SEAT CUSHION

- › 57 LITER • 2882179
- › 28 LITER • 2882507

COOLER WHEELS

- › 28 LITER • 2882180

BOTTLE OPENER

- › 2882183
ALL COOLERS

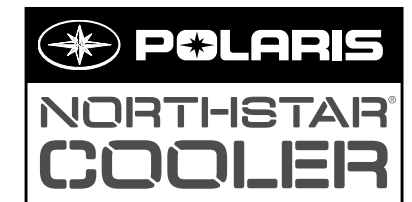



SPECIFIC NEEDS, ***SPECIFIC OILS***

Polaris invests millions in engine development, and part of that investment is making sure its lubricants—critical to engine performance—are the right formula for your specific engine. The amount of testing data and engineering resources used in developing Polaris lubricants would overwhelm an aftermarket company. Therefore, the aftermarket must spec an oil to an industry-wide standard that must account for a variety of operating parameters.

PS-4 is designed specifically for Polaris 4-cycle engines and has high film strength and wear protection under extreme loads and temperatures. Exclusive anti-wear additives protect engine parts with extra rust and corrosion protection.

PS-4 FULL-SYNTHETIC OIL

• PS-4 is optimal for ambient operating temperatures of -40° C to 38° C

- » 1L • 2877263
- » 4L • 2877264
- » 25 L • 2877868
- » 60 L • 502338
- » 200 L • 2878003

PS-4 OIL CHANGE KIT

• Contains the correct amount of oil for your vehicle and correct oil filter

- » 2202166
SINGLE 570, TWIN 600, TWIN 700, TWIN 800
- » 2879323
RANGER/RZR 900/1000
- » 2880913
POLARIS ACE/ETX 325
- » 2877473
330500, SPORTSMAN 550/850/1000

PS-4 EXTREME-DUTY FULL-SYNTHETIC OIL

• PS-4 Extreme Duty is optimal for ambient operating temperatures of -18° C to 53° C

- » 1L • 2879037
- » 4 L • 2879251
- » 25 L • 2879252
- » 60 L • 2879003
- » 200 L • 2879038

POLARIS® PS-4

VS
THE COMPETITION

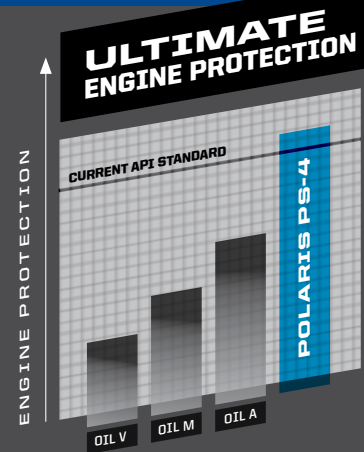

Polaris PS-4 oils exceed the latest industry protection standard as set by the API, while the competition uses standards from years ago. Our proprietary additives clean and protect critical engine parts under high operating temperatures.

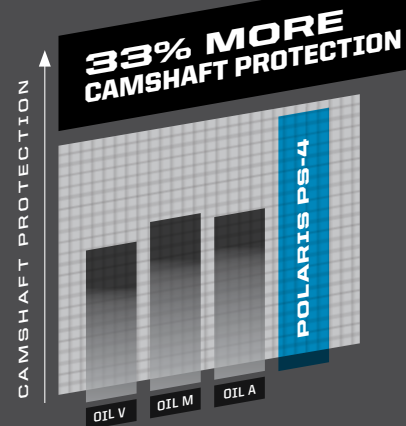

When tested against competitive oils, camshaft bearing races and lobes exhibit less wear when protected by Polaris PS-4 oil.

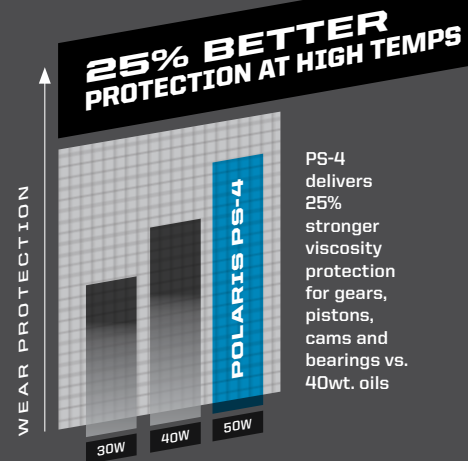

WHY VISCOSITY MATTERS: Polaris engines are designed to operate using oils rated at a specific viscosity. Viscosity is the measure of an oil's resistance to flow and shear and a way to gauge an oil's "film strength", which is a critical component in preserving engine life when an oil is subject to high heat or heavy loads.



PS-4 ***RACE PROVEN PERFORMANCE***

"The Baja 1000 is probably the toughest race in the world! In the brutal Baja desert there are so many things that can ruin your race it is great to know that Polaris Engineered™ Lubricants will never let us down.

We trust in the Polaris® products like the PS-4 motor oil to protect our machines vitals, they are a critical part of a winning formula."

BILL SCHUELER
CREW CHIEF JAGGED X

ENGINEERED TO MAXIMIZE THE LIFE OF YOUR RIDE

All Polaris fluids—from anti-freeze to brake fluid—are developed for your vehicle. Trust the only fluids perfectly engineered for your needs.

DOT 4 BRAKE FLUID

Polaris DOT 4 Brake Fluid is a high-quality brake fluid designed for use in Polaris hydraulic brakes. Superior high-temp characteristics plus anti-corrosive additives extend the life of brake system components and provide consistent, positive braking.

» 250 mL • 502081

ANTI-FREEZE

Polaris Extended Life Coolant contains organic acid technologies to prevent corrosion on metal components, eliminate scaling, and maximize cooling system performance.

» 1 L • 502103
» 25 L • 502271
» 206 L • 502091

DEMAND DRIVE FLUID

Engineered specifically for Polaris ORV front drive systems. Provides positive 4WD engagement in extreme cold or high heat conditions. Unique friction additives protect internal components under heavy loads and promote positive engagement.

» 1 L • 502094
» 200 L • 502264
» 25 L • 502267

AGL

A proprietary blend of additives designed to optimize Polaris ORV transmission life. Extreme pressure additives protect gears, drive chain, and bearings from scoring and wear. Unlike typical gear case oils, AGL's unique viscosity range allows instant flow and film protection in extreme cold or high heat environments.

» 1 L • 502080
» 200 L • 502151
» 25 L • 502152

Proper lubricant application and timing will ensure optimal vehicle performance. Please refer to your owner's manual for lubricant change interval schedules.

CARBON CLEAN

Polaris Carbon Clean prevents ethanol corrosion, stabilizes fuel, and cleans fuel injectors, piston ring lands, intake systems, and combustion chambers. Helps maintain peak HP and improves fuel economy.

» 125 mL • 502082

FUEL STABILIZER

Fuel Stabilizer prevents ethanol corrosion and stabilizes fuel for up to 2 years. Dual-antioxidant formula protects against gum and varnish for easy starting.

» 125 mL • 502100

ANGLE DRIVE FLUID

» 1 L • 502089
» 25 L • 502268
» 202 L • 502266

SPORTSMAN®, RANGER®, RZR® ANGLE DRIVE GEAR CASE SYSTEMS

PREMIUM GAS SHOCK OIL

» 1 L • 502098

ALL-SEASON GREASE TUBE

» 400 g • 502068



NOTHING CAN STOP YOU. COVERAGE WHEN YOU NEED IT.

FIX ON THE GO | TEMPORARY COVERAGE

CV BOOT REPAIR KIT*

- A quick trail side fix to increase trail time.
- The flexible and durable boot material expands over a cone tool for CV boot repairs, without disassembling CV axles.
- Universal fit - works as a temporary fix for most powersports axles.
- All components fit inside the cone, and a cover is provided for compact durable storage.
- Easily fits in a cargo box, attached to the roll cage, in the glovebox, or many other storage locations.



Items shown are contained inside cone

UTV CV BOOT REPAIR KIT

- Kit includes the following items:
 - (1) Expandable XL CV Boot
 - (1) Reusable Cone Tool
 - (2) CV Boot Clamps
 - (1) Tube of Silicone Lube
 - (1) Grease Packet
 - (1) Cone Cover
- » 2830526 • \$35⁹⁹

UTV TRAIL BOOT ONLY

» 2830527 • \$17⁹⁹

ATV

» CV REPAIR KIT 2830528 • \$31⁹⁹
» TRAIL BOOT ONLY 2830529 • \$17⁹⁹

HOW TO INSTALL

- Remove wheel and axle nut
- Remove brake caliper, hub, tie rod, & upper & lower ball joints
- Remove old boot & clean joint
- Spread silicone lube on entire cone tool. Slide boot over cone tool, large end first. See package for outer boot instructions.
- Empty the bag of grease into the CV joint/boot, clean sealing points & install clamps
- Reassemble tie rod, ball joints, brake caliper, axle nut, tire & wheel

Refer to your owner's manual for further instructions and torque specifications.

*Designed for temporary CV boot repair. Purchase the OEM CV Boot for a permanent repair.

FOR THE LIFE OF YOUR RIDE

THE KEY TO KEEPING YOUR POLARIS® OFF-ROAD VEHICLE PERFORMING as well as the day you brought it home is proper maintenance. Items like belts, filters, and batteries represent only a few of these critical items engineered specifically by Polaris®.

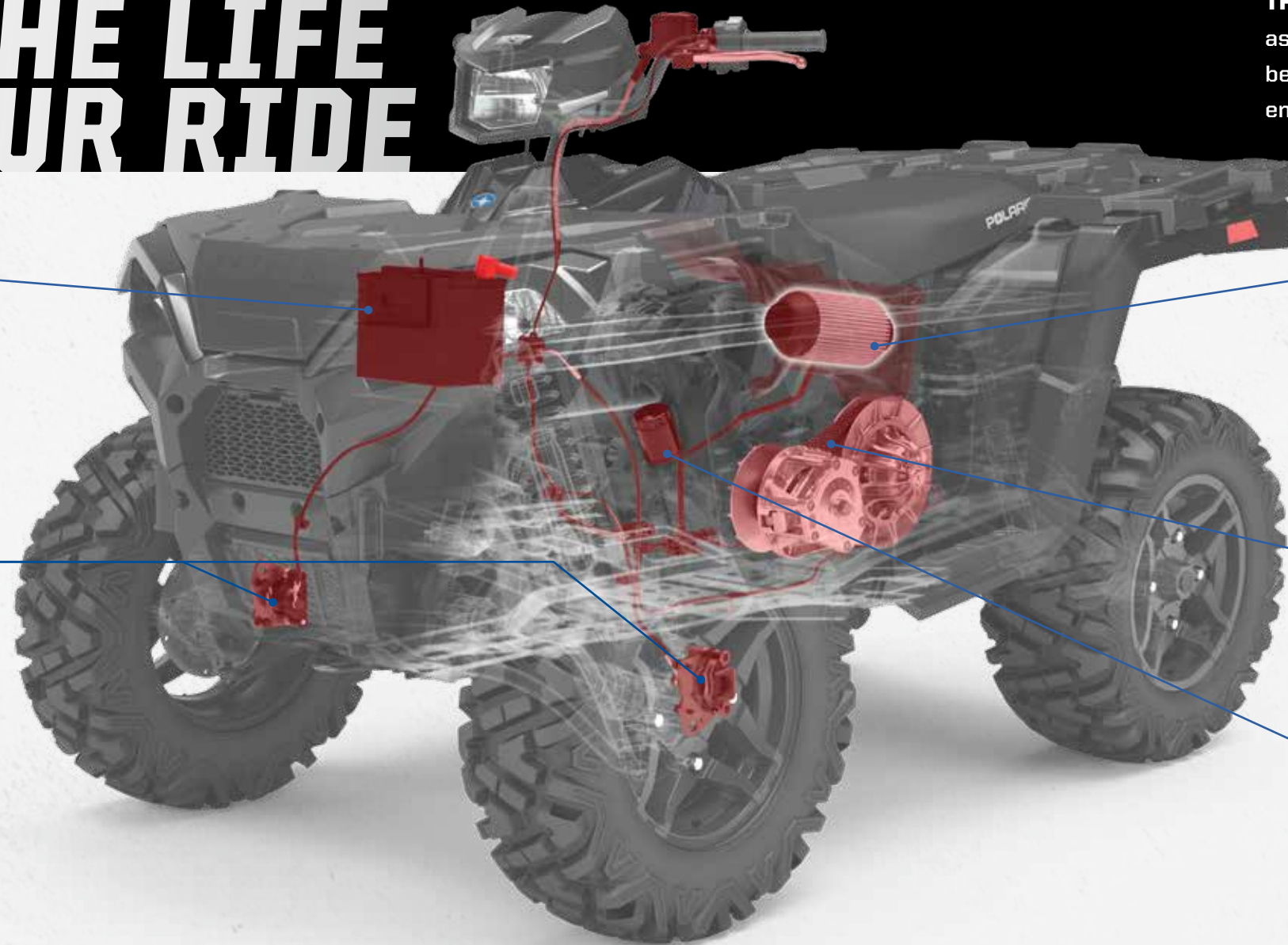

BATTERIES

Never leave a battery unattended during the storage season. To ensure your battery maintains its level of charge when unused for extended periods of time or during freezing weather, the battery should be connected to a BatteryMINDER®. Be sure to check for corrosion from the terminals to the ends of the cables.

BRAKE PADS

Check your brakes if you are close to the recommended service interval, hear grinding when applying the brakes, your vehicle is taking longer to stop or if you have to apply more pressure to your pedal to engage the brakes. Check the brake discs for signs of cracks, excessive corrosion or warping.

If the brake pads are contaminated with oils or grease (petroleum products), brake pads have to be discarded and replaced.

Discs need to be cleaned with brake cleaner or alcohol based cleaner only.

AIR FILTERS

Critical to engine performance and reliability. A clogged air filter can restrict air flow to the engine leading to reduced engine performance. Dirt and debris ingestion can damage the engine leading to reduced engine life or catastrophic failure. Polaris® recommends changing the vehicle's air filter at the specified intervals outlined in the owner's manual, which may be shorter if your vehicle is subject to severe conditions.

DRIVE BELTS

Polaris Engineered® belts deliver unmatched performance for your off-road vehicle. Developed and tested on all our engines for all environments and conditions. Check your belt for delamination, hour glassing and glazing.

OIL FILTERS

Change oil filters with every oil change to provide the best protection for your engine. Superior engine protection keeps your engine operating at peak performance. Be sure to follow the suggested service intervals for oil/oil filter changes.

MAINTENANCE TIP

BREAK-IN PERIOD

The break-in period for your new Polaris Sportsman® is the first 25 hours of operation, or the time it takes to use the first two tanks of fuel. No single action on your part is as important as a proper break-in period. Careful treatment of a new engine will result in more efficient performance and longer life for the engine. Perform the listed procedures carefully.

NOTICE: Excessive heat build-up during the first three hours of operation will damage close-fitted engine parts. Do not operate at full throttle or high speeds for extended periods during the first three hours of use.

MAINTENANCE SCHEDULE

25 HRS/400 km	50 HRS/800 km	100 HRS/1600 km	150 HRS/2400 km	200 HRS/3200 km	350 HRS/4020 km	500 HRS/8045 km	CHECK YOUR OWNER'S MANUAL FOR ADDITIONAL RECOMMENDED SERVICE ITEMS AND VEHICLE-SPECIFIC TIMING
BREAK-IN MAINTENANCE ENGINE OIL: CHANGE GENERAL LUBRICATION: ALL FITTINGS, PIVOTS, CABLES, ETC. AIR FILTER: INSPECT & CLEAN REPLACE AS NEEDED EXHAUST SYSTEM: INSPECT & CLEAN INSPECT FOR LEAKAGE OR CARBON BUILD UP AT JOINTS INSPECT & CLEAN SCREEN TYPE SPARK ARRESTOR	6 MONTHS EXHAUST SYSTEM: INSPECT & CLEAN INSPECT FOR LEAKAGE OR CARBON BUILD UP AT JOINTS INSPECT & CLEAN SCREEN TYPE SPARK ARRESTOR GENERAL LUBRICATION: ALL FITTINGS, PIVOTS, CABLES, ETC. DRIVE BELT: INSPECT & ADJUST REPLACE AS NEEDED	12 MONTHS ENGINE OIL: CHANGE DRIVE BELT: INSPECT & ADJUST REPLACE AS NEEDED TRANSMISSION FLUID: CHANGE EXHAUST SYSTEM: INSPECT & CLEAN INSPECT FOR LEAKAGE OR CARBON BUILD UP AT JOINTS INSPECT & CLEAN SCREEN TYPE SPARK ARRESTOR	18 MONTHS ENGINE OIL: CHANGE BATTERY: TEST, CLEAN, & CHECK FLUID LEVEL REPLACE AS NEEDED DRIVE BELT: INSPECT & ADJUST REPLACE AS NEEDED TIRES: INSPECT CONDITION & PRESSURE EXHAUST SYSTEM: INSPECT & CLEAN INSPECT FOR LEAKAGE OR CARBON BUILD UP AT JOINTS INSPECT & CLEAN SCREEN TYPE SPARK ARRESTOR	24 MONTHS ENGINE OIL: CHANGE BRAKE PADS & FLUID: INSPECT & CLEAN REPLACE AS NEEDED SPARK PLUGS: INSPECT REPLACE AS NEEDED EXHAUST SYSTEM: INSPECT & CLEAN INSPECT FOR LEAKAGE OR CARBON BUILD UP AT JOINTS INSPECT & CLEAN SCREEN TYPE SPARK ARRESTOR	30 MONTHS ENGINE OIL: CHANGE BATTERY: TEST, CLEAN, & CHECK FLUID LEVEL REPLACE AS NEEDED DRIVE BELT: INSPECT & ADJUST REPLACE AS NEEDED GENERAL LUBRICATION: ALL FITTINGS, PIVOTS, CABLES, ETC. EXHAUST SYSTEM: INSPECT & CLEAN INSPECT FOR LEAKAGE OR CARBON BUILD UP AT JOINTS INSPECT & CLEAN SCREEN TYPE SPARK ARRESTOR	36 MONTHS ENGINE OIL: CHANGE AIR FILTER: INSPECT, CLEAN REPLACE AS NEEDED COOLANT: CHECK LEVEL REPLACE EVERY 2 YEARS GEARCASES: CHECK OIL LEVEL EXHAUST SYSTEM: INSPECT & CLEAN INSPECT FOR LEAKAGE OR CARBON BUILD UP AT JOINTS INSPECT & CLEAN SCREEN TYPE SPARK ARRESTOR	

SERVICE PARTS

Polaris Engineered™ service parts deliver unmatched performance and fit for your off-road vehicle.

All service parts are developed and tested for your vehicle. Half shafts, bushings, bearings, decals, side panels, electrical components, and clutching components are the same parts that are manufactured on the factory lines for each specific vehicle. This ensures it doesn't merely fit your vehicle - it outperforms your expectations!

VISIT YOUR POLARIS® DEALER TO SHOP FOR SERVICE PARTS.

OVER
100,000
PARTS
AVAILABLE!



FOR THE LIFE OF YOUR RIDE

Maintenance is the key to keeping your Polaris off-road vehicle performing at its peak. Items like belts, lubricants, and batteries represent only a few of these critical items engineered specifically by Polaris.



POLARIS ENGINEERED DRIVE BELTS

TESTED, PERFECTED

We test each belt on the intended vehicle - we don't just try to make an existing belt "just work".

- Amery Kuhl, Polaris® CVT System Engineer

OUR INVESTMENT

- 32,187 km of field testing
- Thousands of dyno hours
- 18+ months of development (3,000+ design hours) per belt
- 1200+ vehicle validation hours
- Collaboration with powertrain & clutch engineers

YOUR ADVANTAGE

- No clutch recalibration
- Less wear & tear due to heat
- Ensure maximum performance of your vehicle
- More time out riding, less time wrenching

**OUR INVESTMENTS ENSURE POLARIS BELTS
OUTPERFORM YOUR EXPECTATIONS.**

LIFT IT SECURELY LIFT IT SAFELY



POLARIS® VEHICLE LIFT

- Get fast, easy access to the underside of your vehicle
- Manual and pneumatic operation available
- Raises vehicle up to 81 cm to make repairs and maintenance faster and easier

» 544 kg • 2830424

LIFT ATTACHMENTS

- Add the appropriate attachment to use your lift for all your off-road vehicles

- » ATV/POLARIS ACE® • 2830427
- » SNOWMOBILE • 2830426



POLARIS® X3 CREEPER

- Three positions: flat, 45-degree angle or seated work stool
- Helps you perform any repair with ease
- Stay dry and warm away from cold, wet cement floors
- Easily stores away when not in use

» BLACK • 2830429



SHOP ACCESSORIES



POLARIS® MAGNETIC PARTS TRAY

» SILVER • 2830432



POLARIS® 8.4 cm TELESCOPIC MAGNET

» BLACK • 2830435



POLARIS® 30.5 cm HI-TORQUE RATCHETING DRIVER

» BLACK / BLUE • 2830434



POLARIS® LED POCKET FLASHLIGHT

» BLACK • 2830436



KEEP IT CLEAN

CLEAN ALL-PURPOSE CLEANER

• Professional cleaner, which is formulated with a low pH-value. The product spreads well on surfaces and adheres on them for effective cleaning action. Perfectly compatible with rubber, plastic and painted surfaces. The formulation is biodegradable.

» 500 mL • 502309

SHINE INSTANT SHINE & DETAILER

• The INSTANT SHINE AND DETAILER is developed for cleaning action without water. Removes insects, dust and dirt with almost no effort. Applicable for plastics, visors, windscreens, paint and metal. The wipe and shine formulation makes surfaces shine, works water repellent and also has an antistatic effect. Perfect for customers living in urban areas with no access to water, for bike trips or showroom bikes.

» 500 mL • 502303



TRAILERING



RAMP PRO BY CALIBER®

- Designed for ATVs and UTVs up to 127 cm wide
- Integrated grip glides for ultimate traction
- Folding sides for easy transportation & storing
- » 132 cm x 229 cm • 2883005



ALUMINUM ARCHED LOADING RAMPS

- » 193 cm x 30.5 cm • 907 kg • 2875384
- » 224 cm x 30.5 cm • 1361 kg • 2875386



LIGHTWEIGHT TRI-FOLD RAMPS

- Ramp folds up for transport
- Capacity for up to 680.7 kg
- Safety straps included
- » 183 cm x 130 cm • 2875385
- » 208 cm x 130 cm • 2875860

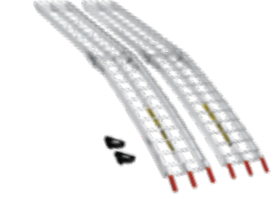

FOLDING ALUMINUM ARCHED RAMPS

- Ramp folds up for transport
- Capacity up to 1361 kg
- Safety straps included
- » 224 cm x 30.5 cm • 2875387

HITCHES

3:1 HITCHES VERSATILE 3 IN 1 FUNCTIONALITY

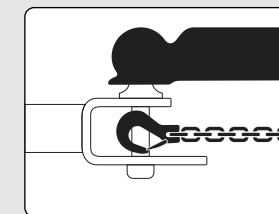

BALL

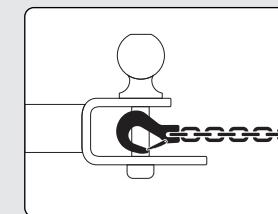

HOOK

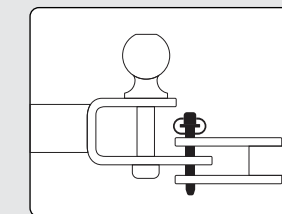

PIN

- Ball, pin and hook design
- Durable steel construction
- Rust resistant, black powdercoated finish
- Removable ball
- Heavy Duty 5/8" pin and clip



NEW HITCH WITH 2" BALL

- » 2" x 2" RECEIVER 2830522
- » 1 7/8" x 1 1/2" RECEIVER 2830523



NEW 1 7/8" BALL

- 1 7/8" replacement ball for hitch
- Designed to work with 3:1 Hitch
- » 2830524



RECEIVER HITCH

- » 2" RECEIVER TONGUE 2875320
- » FRONT HITCH RECEIVER 2878846



TRAILER BALL 3/4" SHANK

- » 1 7/8" BALL • 2877602
- » 2" BALL • 2877603

STRAPS & ROPES

NEW RECOVERY STRAP

- 5.1 cm x 9.1 m (8165 kg)
- Comes with carry bag
- » 2884033



NEW RATCHET STRAP

- 3.8 cm x 4.6 m straps, 2 Pack
- Heavy duty webbing
- 2495 kg maximum load, 831 kg working load
- » 2884031



NEW RATCHET STRAP

- 5 cm x 6.1 m Ratchet Straps
- Heavy duty webbing, floating D-rings, double J-hooks
- 4536 kg maximum load, 1497 kg working load
- » 2884032



SHOCK STRAPS

- 3.8 cm 1361 kg breaking strength
- Keeps tension on tie-down straps to secure load, 2 Pack
- » 3.8 cm x 4.6 m • 2883296
- » 3.8 cm x 2.1 m • 2883295

COVERS



TRAILERING COVERS BY POLARIS®

- » 2876614 ALL SPORTSMAN® EXCEPT 300/400, X2, TOURING
- » 2877999 ALL SPORTSMAN® TOURING

- » 2877998 ALL SPORTSMAN® X2
- » 2880056 ALL POLARIS ACE® EXCEPT 900 XC



ORV RIDING JERSEY

- » S-3XL
2868711 • LIME
2867941 • PINK
2867942 • RED



SOFTSHELL JACKET

- Lined with 280 grams of fleece for warmth
- Removable hood
- Armpit zips for venting
- » S-3XL
- » MEN'S
2869919 • BLUE/ORANGE
2869918 • BLACK
- » WOMEN'S
2869921 • CORAL
2869920 • BLACK

WARM

COOL

BE PREPARED FOR ANYTHING NATURE THROWS AT YOU FIND YOUR PERFECT HELMET! RIDE SAFE - OUR HELMETS ARE DOT/ECE CERTIFIED

COOLING SHIRTS

- 100% Poly, chemical-free patented fabric from CoolCore®
- Moisture wicking to keep you dry and cool
- UPF 45+
- » S-3XL
- » MEN'S
2868753 • GRAY
- » WOMEN'S
2868755 • GRAY/PINK

KINGPIN DIRT 509 GOGGLE

- Quick change lens & triple layer foam
- Anti-fog & anti scratch
- » ONE SIZE
2868671 • LIME
2868668 • ORANGE

POWERED BY coolcore

Moisture Wicking, Moisture Transportation, Regulated Evaporation

COOL

NEW RAIN SUIT

- Lightweight
- Waterproof
- Packs small
- Removable hood
- YKK® zippers
- » JACKET • 2869527
S-3XL
- » PANT • 2869528
S-3XL

DRY

TENACITY HELMET

- All the style and protection in our most affordable helmet
- Injection molded plastic
- 1450 grams
- » XS-3XL
- 2868624 • PINK GLOSS 2868619 • BLACK MATTE
2868620 • BLACK/GRAY 2868623 • RED GLOSS
2868622 • BLUE GLOSS 2868621 • LIME GLOSS

PROTECT YOUR HANDS

OFF-ROAD RIDING GLOVES

- As seen in images at left
- » S-3XL
2867937 • PINK 2867936 • RED
2867933 • GRAY 2867935 • ORANGE
2868712 • BLUE/LIME 2867934 • BLUE

509° ALTITUDE CARBON HELMET

- Durable, ultra lightweight, Carbon Fiber
- Full carbon fiber shell
- 1100 grams
- » S-4XL
2867814 • MATTE BLACK
2867815 • GLOSS BLACK

509° ALTITUDE HELMET

- Stylish, Lightweight with 509 Fit and Finish
- Thermoplastic poly alloy out shell
- 1260 grams
- » S-4XL
- 2868539 • LIME 2867819 • RED
2867820 • BLUE 2867817 • GRAY
2867818 • ORANGE



WOMEN'S ASYMMETRICAL HOODIE

» S-3XL
BLACK • 2868597

WOMEN'S ROSEAU TEE

» S-3XL
GRAY FROST • 2869559
BLACK • 2868586



MEN'S RETRO LOGO HOODIE

» S-3XL
BLACK • 2869549
CHARCOAL/LIME • 2869578
GRAY/ORANGE • 2868577

MEN'S RETRO CAP

» ONE SIZE
NAVY/LIME • 2869543

MEN'S ROSEAU HOODIE

» S-3XL
CHARCOAL HEATHER • 2869553
NAVY HEATHER • 2868575
OLIVE HEATHER • 2868576



MEN'S LONG SLEEVE TECH 1/4 ZIP

» S-3XL
BLACK/RED • 2869535
GRAY/LIME • 2869536



MEN'S TRAIL MID LAYER

» S-3XL
GRAY/BLACK • 2869925

MEN'S TECH MESH BEANIE

» ONE SIZE
BLACK • 2868650



WOMEN'S CAMO HOODIE

» S-3XL
CAMO/PINK • 2867898

MEN'S CAMO TECH FULL ZIP

» S-3XL
CAMO • 2869590



MEN'S RETRO TRUCKER CAP

» ONE SIZE
RED • 2869540

MEN'S LONG SLEEVE RETRO TEE

» S-3XL
GRAY • 2868571

WOMEN'S BASEBALL 3/4 SLEEVE TEE

» S-3XL
WHITE/GRAY • 2869563



RETRO CLOCK

» 2868662

PINT GLASS SET OF 2

» 2866265



CAMO WATER BOTTLE

» 2867962

CAMO COFFEE TRAVEL MUG

» 2867961

CAMO BOTTLE KOOZIE

» 2867964

CAMO CAN KOOZIE

» 2867963

CAMO STEERING WHEEL COVER

» 2868663

CAMO BOTTLE OPENER NOT SHOWN

» 2867965



MEN'S ESTA TEE

» S-3XL
CHARCOAL HEATHER • 2869552
NAVY • 2869562
BLACK • 2868570

MEN'S FULL ZIP HOODIE

» S-3XL
BLACK/RED • 2869530
NAVY • 2869532 NOT SHOWN

MEN'S RETRO CAP

» ONE SIZE
CHARCOAL • 2869542



WOMEN'S HEX TEE

» S-3XL
GRAY FROST • 2869566
NAVY FROST • 2869565

WOMEN'S RETRO CAP

» ONE SIZE
BLUE • 2869547

WOMEN'S SCRIPT CREW SWEATSHIRT

» S-2XL
AQUA • 2869557

WOMEN'S RETRO HOODIE

» S-3XL
NAVY • 2869555



MEN'S ROSEAU TEE

» S-3XL
CHARCOAL HEATHER • 2869560
HEATHER BLUE • 2867778
ASH HEATHER • 2869561



KEEP IT COLD.



SEE THE FULL LINE OF COOLERS
INCLUDING THE NEW 14 LITER MODEL
WITH AN EASY CARRY HANDLE

SEE P. 44

UNLESS NOTED, TRADEMARKS ARE THE PROPERTY OF POLARIS INDUSTRIES INC. 509® is a registered trademark of Teton Outfitters, LLC. Batteryminder® is a registered trademark of VDC Electronics Inc., Bluetooth® is a registered trademark of Bluetooth Sig. Inc., Browning® is a registered trademark of Browning Corporation, Caliber® is a registered trademark of Caliber, Inc., CREE® is a registered trademark of Cree, Inc., COOLCORE® is a registered trademark of Tempnology LLC., FOX® is a registered trademark of Fox Factory Inc., Mathews® is a registered trademark of Mathews Archery Inc., Maxxis® is a registered trademark of Cheng Shin Rubber Ind. Co., Ltd., MB Quart® is a registered trademark of Maxxsonics USA Inc., Mossy Oak® is a registered trademark of Haas Outdoors, Inc., MTX® is a registered trademark of Mitek Corporation, OGIO® is a registered trademark of Ogio International, Inc., Rigid® is a registered trademark of Rigid Hitch, Inc., Tiger Drylac® is a registered trademark of TIGER COATINGS GMBH & CO. KG, Walker Evans Racing Shocks® registered trademark Walker Evans Enterprises Corp., Velcro® is a registered trademark of VELCRO BVDA, Yeti® is a registered trademark of Yeti Coolers, LLC, YKK® is a registered trademark of YKK Corporation. Prices and availability are subject to change at any moment. Copyright © 2018 Polaris Industries Inc. All rights reserved. Availability varies by market, check your local dealer for availability.



POLARIS®

MY19 SPTSMN/ACE APP EMEA